

GIBBY'S GUIDE TO THE QUEST 2!

A FREE INDEPENDENT VR ZINE!

V19 | SEPT/OCT 2022

LOVINGLY CURATED!

COMPLETE BEGINNER'S GUIDE!

FULLY REVISED & UPDATED!

TOP
100
RANKED &
REVIEWED

300,000
DOWNLOADS!

299
FEATURED
TITLES

140
PAGES



PLUS! QUEST PRO LAUNCH!

the future of
medicine

MEET THE DEVELOPERS! TOMÁŠ BRNGÁL VIRTUAL MEDICINE | TOMEK KUPIDURA MEDICALHOLODECK

FULLY

**CLICK ON ANY ICON TO
TAKE YOU TO THE CONTENT!**

INTERACTIVE!

BRAND NEW

**GO TO THE BLUE REFERENCE
PAGES TO GET STARTED!**

TO QUEST 2?

26

MEET THE DEVS!

13 GAMES!

85 CREATION & EDUCATION!

100 FILMS & ANIMATIONS!

129 GETTING STARTED!

KEY!



roomscale essential



best in roomscale



perfect for seated



air passthrough



hand tracking



replay value



creative tool



meditation



adventure



sports



fitness



puzzle



possible motion sickness



GENERAL PRACTICE

FREE STUFF!



Download issue **v18** for a fully revised and updated guide to all the best **FREE** games, apps, films and animations available to download and play right now!

ABOUT THIS ISSUE!

Come on a Fantastic Voyage inside the new frontier of medical VR with Tomáš Brngál from **virtual medicine** and **medicalholodeck's** Tomek Kupidura. Both apps are available for a free trial for you to try today. From educational tools to study human anatomy to pre-surgical planning for medical professionals, VR is set to change the game.

MORE FREE DLC!



25% OFF ALL GAMES IN THIS GUIDE!

With the new **app referral** scheme, you can give friends 25% off any title you own and get \$5 back in return. I have a policy of paying for all apps and now you can help me! You can find all my referral links **here**.

PCVR WITHOUT THE PC?

All the titles in this guide are native to Quest 2, no PC required! But you can try PCVR with services that offer VR cloud gaming, Shadow PC and Plutosphere. Meta is working on its own service, Avalanche.

TRIGGER WARNINGS

I won't play, review or promote any title that has scenes of suicide and self-harm without any trigger warnings for parents or users. It's irresponsible and unacceptable. End of.

ABOUT THIS GUIDE!

The guide started life as a one-off pandemic passion project and keeps growing! It's **fully updated and revised every month** or so. Each new edition features interviews with developers. **I pay for all apps!** First, I believe in supporting the developers, big or small. Second, you know that you are getting a completely unbiased and independent view. This isn't supposed to be a comprehensive guide - I like to make **positive recommendations** of the stuff I like and look beyond the hype. It all comes down to personal choice in the end - each to their own!

gibby@gibbysguide.org

QUEST PRO LAUNCH!



AT A GLANCE \$1,500

- Hi res colour passthrough
- Lighter pancake lenses
- Face and eye tracking
- Rear battery
- Self-tracking controllers
- 256G storage
- 12G RAM

AVAILABLE FROM OCT 25!

Is it a first generation mixed reality headset? A developer kit? An enterprise tool? Whatever the Quest Pro is, it's not the headset that is designed to replace the consumer Quest 2.

Many of the specs - including the smaller shape with pancake lenses and colour passthrough - will be present in the Quest 3 expected late 2023. There's no reason for the vast majority of users to buy, not least due to the price of \$1,500.

Launched at Meta's annual Connect conference on Oct 11 and available from Oct 25, the Quest Pro is first headset to be released from the company since the Quest 2 in October 2020.

Its flagship feature of colour passthrough promises to drive the first generation of AR apps and games.

But the headset is primarily aimed at the business market to be used on Meta's suite of apps from Workrooms to Horizon.

There are improvements across the board with a slightly higher field of view, increased pixels per eye, adjustable IPD (55mm-75mm) and self-tracking controllers. The controllers are also compatible for Quest 2 and cost \$300.

However battery life for the headset is estimated to be just 1-2 hours. And the unibody design with rear battery prevents use of third party straps with extra power.

By default the Quest Pro is designed to be worn as an AR headset. It comes with magnetic Partial Light Blockers that can be attached at the sides but allows light leakage from below. For full VR immersion the Full Light Blockers cost \$50.

With Apple poised to enter the market in 2023, the Pro is Meta's pre-emptive strike. The Quest 2 itself is being challenged by the Pico 4 which launches on Oct 18 (not in the US) with colour passthrough and pancake lenses but, crucially, without a comparable library of apps and games.

NEW FOR QUEST 2!

click the icons to go to the experiences!

into the radius post-apocalyptic survival!



red matter 2 spectacular sci-fi adventure!



ultimechs robot wars!



maestro orchestral!



townscaper vr chill building!



moss book II triumphant return of quill!



tales from soda island silence!



iss space eolia fantasy mash me up party games gizmo builder create runner anime bikes



NEW COMING SOON!

click the icons to watch **teaser videos!**

colossal cave text-based adventure reboot!

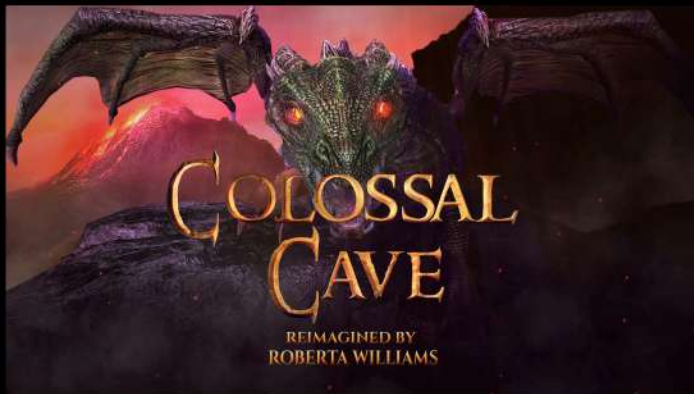

iron man vr take on Ghost!



yupitergrad 2 the lost station!



call of the sea vr tropical island mystery!



woorld multiplayer Google Earth!



behemoth from *saints & sinners* devs!



fight back self-defence interactive animation



ghost signal sci-fi space action!



NEW COMING SOON!

click the icons to watch **teaser videos!**

saints & sinners: chapter 2 retribution!



everslaught invasion fast hack 'n' slash!



warplab portal 3!



among us vr red is sus!



soul of kaeru explore a miniature world



gesture vr life drawing!



untitled laser game in passthrough!



untitled surgeon sim with hand tracking!



NEW COMING SOON!

click the icons to watch **teaser videos!**

drop dead: the cabin co-op shooter!



hellsweeper vr immortal combat!



genotype sci-fi adventure in Antarctica!



espire 2 co-op stealth action!



the last worker survival at Amazon!



nyssa new animation from studio syro!



echowars road rage



NEW COMING SOON!

click the icons to watch **teaser videos!**

hubris sci-fi survival!



helisquad covert operations copter capers!



ziggy's cosmic adventures space fun!



path craft lemmings-like platformer!



propagation paradise hotel survival horror!



gambit heist-style co-op!



killer frequency 80s horror!



affected: the asylum multiplayer horror!



NEW COMING SOON!

click the icons to watch **teaser videos!**

breachers tactical shooter!



broken edge swordfighting!



wallace & gromitt the grand getaway!



divine dual fantasy fighting!



tamers dawn monster catching!



slink & snatch tales of thievery!



upa ugly potatoes affair - AI adventures!



peaky blinders flat cap gangsters!





EASY EXPLAINER!

WHAT IS APP LAB?

A WORLD OF HIDDEN GEMS!

Find all the apps [here](#), [here](#), or [here](#).

App Lab isn't an app or a site, it's a label. You don't have to download anything. All it means is games that haven't yet been given the official seal of approval.

You can find them all on the official store but they are 'hidden'. In other words, they aren't promoted and you can only search for them using their exact name.

Much easier than that is to go to any of the sites that collect all the App Lab games in one place (see above). Then they will link you back to the store where you can download them just like you would any other title. Easy, right?

WHERE TO WATCH FILMS & ANIMATIONS ...

INSTALL THESE FREE APPS!

Films and animations can be viewed on **oculus tv** or one of these apps



VR ANIMATION PLAYER



WHAT IS SIDEQUEST?



STEP-BY-STEP GUIDE

Follow the tutorial [here](#)

It's never been easier use **Sidequest**. It was set up as an alternative to the official store before App Lab came along so you'll find a *lot* of crossover. There are still some gems here though (and you can mess with some of your Quest 2 settings).

Sidequest requires a one-time PC set-up. Put the Sidequest Easy Installer on your headset (see link above) and open in 'unknown sources' at the bottom of the drop-down menu 'All' or 'Installed'.

Then you'll have an in-VR alternative store! Just download and install the titles you want. They will all appear in 'unknown sources'. This is perfectly safe and the creators of Sidequest work with Meta.

You'll have to create a developer account to use Sidequest. Don't be put off - it's ridiculously straight-forward. Follow the tutorial linked above.

Into The Radius

**GAMES &
APPS!**



RANKED! GAMES & APPS!

Emirate
FLY BETTER

TOP 100+
GAMES!
I PAY FOR
ALL APPS!

best of the quest!

Here's my ever-changing *personal* favourite 100 games - ranked for fun!



one! new!
red matter 1 & 2 🏠 🚗
app | \$25 & \$30
surreal & spectacular
sci-fi adventure in space!



two! new!
into the radius 🏠
app | \$30
eerie supernatural stealth
survival shooter!



three!
song in the smoke 🏠 🚗
app | \$30 **R**
soul, spirit, survival



four!
pistol whip 🏠 ❤️
app | \$30 **R**
shoot to the beat in a
cinematic bullet hell!



five!
the walking dead: saints & sinners 🏠 🚗
app | \$40
epic zombie survival!



six! new!
moss book I & II 🏠 🚗
app | \$30 & \$40
magical mouse diorama!



seven!
audio trip 🏠 ❤️
app | \$20 **R**
top-class choreography!



eight!
the climb 2 🏠 🎮 ❤️
app | \$30 **R**
epic free solo climbing!



nine!
green hell vr 🏠 🚗
app | \$30 **R**
Amazonian journey!



ten! multiplayer!
eleven table tennis 🏠 ❤️
app | \$20 **R**
AI ping & multiplayer pong!



eleven! multiplayer!
blaston 🏠 ❤️ 🎮
app | \$20 **R**
duelling AI or randoms!





twelve!
puzzling places 🏠 🚗 🧩 🎮
app | \$15 & dlc **R**
photogrammetry jigsaws!

thirteen to twenty-four!

Buy and try on the official store - you get an automatic refund if you've played for less than two hours and within 14 days of purchase. And look out for sales!



thirteen!



the room vr  
app | \$30
spellbinding detective
mystery!



fourteen!



down the rabbit hole  
app | \$20
gorgeous alice in
wonderland prequel!

fifteen!



crashland 
app | \$20 
aaaaarrrrrrgggggghhhh!
the toughest game in VR?



sixteen!



yupitergrad
app | **free demo** | \$15
superb Slavic spiderman!
* free demo on sidequest!

seventeen! **multi!**



walkabout minigolf 
app | \$15 & dlc 
pitch 'n' putt with friends!

eighteen! **multi!**



real vr fishing   
app | \$20 & dlc 
in Korea, Japan & US West!



nineteen!



i expect you to die 1 & 2 
app | \$25 & \$25
welcome back, agent!



twenty!



phantom: covert ops  
app | \$30
stealth kayaking?! oh, yeah



twenty-one!



superhot vr  
app | **free demo** | \$25
the matrix!



twenty-two!



the last clockwinder 
app | \$25 
self-cloning capers!

twenty-three!



a fisherman's tale  
app | \$15
macro to micro seafaring!

twenty-four!



tea for god  
app lab | **free demo**
non-euclidean geometry!

twenty-five to thirty-six!

twenty-five!



little cities 🚗 🐙
app | \$20 **R**
beautiful and benign
homespun world builder!

twenty-six! **multi!**



the under presents 🌀
app | free | in-app **R**
open world theatrics with
scrunch locomotion!

twenty-seven! **multi!**



ultrawings 2 🚗 🌀
app | \$25
arcade flight sim with
multiplayer dogfights!

twenty-eight!



sweet surrender 🚗
app | \$25 **R**
kick-ass techno roguelite!

twenty-nine!



waltz of the wizard 🌀 🐙
app | \$20
natural magic!

thirty!



**star wars: tales from
the galaxy's edge** 🌀 🚗
app | \$35*
child's play but epic optics!
*including DLC 'Last Call'

thirty-one!



garden of the sea 🌀 🧩 🚗
app | \$25 **R**
cute island-hopping!

thirty-two!



tentacular 🧩 🚗
app | \$25
original squid game!

thirty-three!



cubism 🧩 🧩 🚗 🐙
app | \$10 **R**
puzzle, piano, passthrough

thirty-four! **multi!**



black hole pool 🌀 **R**
app lab | free demo | \$10
perfect pool sim!

thirty-five!



dead second 🏠
app lab | \$20
bodysifting shooter!

thirty-six!



shadow point 🌀 🚗
app | \$20
mystery in Inverness!

thirty-seven to forty-eight!

thirty-seven!



lies beneath 🕸

app | \$30

suspense and surrealism
in graphic novel thriller!

thirty-eight!



myst 🕸 🪑 🧩 🖱

app | \$30

remake of 1993 classic
with hand tracking!

thirty-nine! multi! new!



ultimechs 🎮 🪑

app | free & in-app R

multiplayer robot wars
from Resolution Games!

forty!



resist 🕸 🪑 🕸

app | \$20

weaponised spiderman!

forty-one!



carve 🎮 🕸

app | \$20 R

smooth snowboarding!

forty-two! multi!



ragnarock 🪑

app | \$25 R

crazy viking rhythm race!

forty-three!



deisim 🪑

app | \$15 R

be a powerful God!

forty-four! multi!



traVRsal 🏠

app lab | free

natural walking in VR!

forty-five!



ARK-ADE 🪑 R

app lab | free demo | \$10

inside the game Tron-style!

forty-six! multi!



warplanes: battle over 🕸

pacific app | \$20 R

WWII missions!

forty-seven!



squingle 🧩 🪑 📦

app lab | free demo | \$11

totally trippy puzzler!

forty-eight!

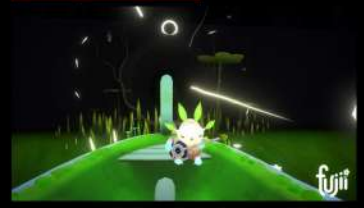

fujii 🧩 🪑

app | \$15

kaleidoscopic gardening!

forty-nine to sixty!



forty-nine!



thrill of the fight   
app | \$10 
the undisputed heavyweight
champion of boxing games!

fifty! multi!



blacktop hoops 
app lab | free demo 
the future of VR basketball
with cool art style!

fifty-one!



daedalus 
app lab | \$5
amazing flying sensations
from Red Matter devs!



fifty-two!



the curious tale of   
the stolen pets app | \$15
touch that cuteness!



fifty-three!



unplugged: air guitar 
app | \$25  
hand tracking guitar hero!



fifty-four!



v-speedway  
app lab | free 
arcade racing!



fifty-five! multi!



stride  
app | \$15 
parkour madness!



fifty-six! multi!



space pirate trainer dx 
app | \$25 
trailblazing arena mode!





fifty-seven!



till tomorrow  
app lab | free demo | \$10
desert island survival!

fifty-eight!



holopoint   
app | \$15 
intense ninja archery!

fifty-nine!



crazy kung fu    
app lab | free demo | \$10
passthrough martial arts!

sixty!



we are one 
app lab | free demo
clone co-op!

sixty-one to seventy-two!



sixty-one! **new!**
eolia 🎯 🧩 🏠 🕹️
app | \$15
hand tracking fantasy tale!



sixty-two! **multi!**
vox machinae 🎯 🏠
app | \$25 **R**
war of the worlds!



sixty-three! **multi!**
nock 🎯 🕹️
app | \$10 **R**
archery-football-ice hockey!



sixty-four! **new!**
maestro 🎯 🕹️
app lab | free
orchestral manoeuvres!



sixty-five!
gravity lab 🧩 🏠
app | \$15 **R**
sexy space puzzles!



sixty-six!
gadgeteer 🧩 🏠
app | \$15 **R**
incredible machine building!



sixty-seven! **multi!**
racket nx 🏠 ❤️ 🕹️
app | free demo | \$20 **R**
some kinda future squash!



sixty-eight! **multi!**
carly and the reaperman 🎯 🏠
app | \$20
play with non-VR in co-op!



sixty-nine!
wind wind 🧩 🏠
app lab | \$20
cute Korean diorama!



seventy!
gladius 🏠
app lab | \$15 **R**
comedy gore!



seventy-one!
shores of loci 🧩 🏠
app | \$15
meditative jigsaws!



seventy-two!
ghost giant 🎯 🧩 🏠
app | \$25
be a huge helping hand!

seventy-three to eighty-four!

seventy-three!



DAVID 🚗

app lab | \$15

sleek 3rd person shooter!

seventy-four! **multi!**



grapple tournament 🏠

app lab | free demo \$15 **R**

swinging mechanic shooter!

seventy-five!



windlands 🌿 🌐

app lab | \$15

classic grapple adventure!

seventy-six!



custom home mapper 🏠

sidequest | \$8

map your entire house!

seventy-seven! **multi!**



guardians

app lab | \$20

sci-fi strategy shooter!

seventy-eight!



time stall 🏠 🧩

app | \$15

save the captain!

seventy-nine!



hand physics lab 🚗 🐕

app | \$10

zany hand tracking tricks!

eighty!



ancient dungeon 🌿

app | free demo \$20

hilarious pixel adventure!

eighty-one!



invaders

app lab | \$15

kitsch arcade tower defence!

eighty-two!



dungeon maker 🏠 🧩

app lab | free **R**

buildeth thy deathly pits!

eighty-three!



cosmodread 🌿

app | \$15

terrifying space maze!

eighty-four!



2076 midway multiverse

app lab | free & in-app 🧩

passthrough space battles!

eighty-five to ninety-six!



gizmo builder 🛠️🧩🔥
app lab | \$10 **R**
ar machine maker!



battlegroup vr 🛠️
app lab | \$25 **R**
sci-fi strategy shooter!



atmos arena 🛠️🌀
app lab | free **R**
grapple racing!



pioneer: endless journey
app lab | free **R**
Arabian space shooter!



<RUNNER> 🛠️
app | \$15 **R**
arcade anime bike action!



tower tag
app lab | free **R**
paintball-style shooter!



replika 🛠️
app lab | free & in app **R**
it's Spike Jonze's *Her*!



journey of the gods 🍀🛠️
app | free demo | \$30
God-mode adventures!



no more rainbows 🏠
app lab | free demo
physical platformer!



the atlas mystery 🧩
app lab | \$15
theatre escape room!



finger gun 🛠️🔥
app lab | \$15 **R**
point and shoot!



HAX
app lab | free demo **R**
cel-shaded shooter!

ninety-seven to one hundred!



ninety-seven! **multi!** **new!**
mash me up 🎮
app lab | free **R**
party games!



ninety-eight! **multi!**
mothergunship: forge
app | \$20 **R**
mad weapon building!



ninety-nine!
the final overs 🏠 🎮
app lab | free **R**
knock 'em for six!



one hundred!
extreme escape 🏠
app lab | \$5
vertiginous escape room!



bonus! **new!**
handpan vr 🎮 🎵
app lab | \$15 **R**
meditative percussion!



bonus! **multi!** **new!**
saber city 🏠 🎮
sidequest | free **R**
pioneering ar duelling!



bonus!
return to castle wolfenstein | free 🎮
sidequest
Dr Beef VR port of classic!



bonus! **multi!**
first person tennis 🏠 🎮 ❤️
app | \$23 **R**
get your Raducanu on!



bonus! **multi!**
chess club 🎮 🧩 🎮
app | \$15 **R**
battle chess in Stonehenge!



bonus! **multi!**
gods of gravity 🎮
app lab | free **R**
space strategy!



bonus! **new!**
townscaper vr 🎮
app lab | \$10 **R**
chill city building!



bonus!
district m
app lab | free **R**
roller-blading platformer!

bubbling under!

These games are also recommended and reviewed in the guide although they didn't make the top 100. Click on the icons to take you to the store.

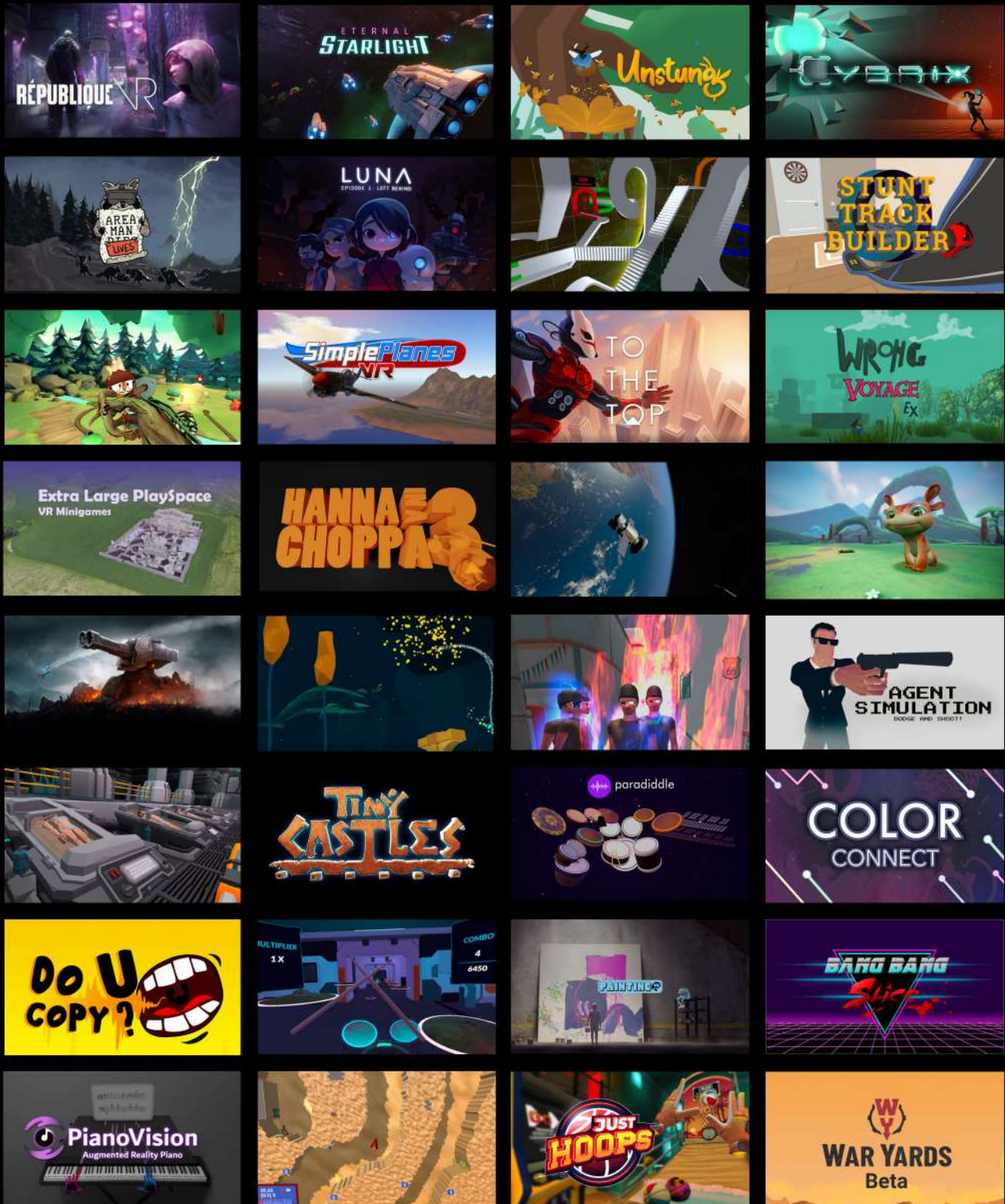

[république vr](#) | [eternal starlight](#) | [unstung](#) | [cybrix](#) | [area man lives](#) | [luna: episode one](#)
[downside up](#) | [stunt track builder](#) | [acron: attack of the squirrels](#) | [simple planes vr](#) | [to the top](#)
[wrong voyage ex](#) | [extra large playspace mini games](#) | [hanna in a choppa 3](#) | [space walk vr](#)
[experience](#) | [bogo](#) | [iron guard](#) | [flowborne](#) | [city of eternity](#) | [agent simulation](#) | [directive nine](#)
[tiny castles](#) | [paradiddle](#) | [color connect](#) | [do u copy?](#) | [grooVR](#) | [painting vr](#) | [bang bang slice](#)
[piano vision](#) | [galaxy forces vr](#) | [just hoops](#) | [war yards](#)

weird & wonderful!

Bonus! Really random shit that pops up on App Lab and Sidequest!



playing VR with girlfriend
app lab | \$10
just ... no.



high voltage electrical substation training
app lab | free
catchy name, hot app!



industrial dishwasher simulation
app lab | free
washing up in Finnish!



VR pigeons ❤️
app lab | \$3
do yourself a favour -
just watch the trailer!



beers and boomerangs
app lab | free demo
throw another shrimp on
the barbie, mate!



the american dream
app | \$15
guns, guns, guns, guns,
guns, guns, guns!



into the metaverse 🏠
app lab | \$10
the story of storytelling!



don't upset bobby 🧩
app lab | free
threatening freak doll!



rollercoaster vr box 🌀
sidequest | free
genius vomit fest!

multiplayer!



golf pool vr 🏌️‍♂️
app lab | \$6
... on the moon!

multiplayer!



flying squirrel chase 🏠
app lab | free
flap your wings!



who do you voo doo 🏠
app lab | \$1
name your doll and kill!

COVER FEATURE
**THE FUTURE OF
MEDICINE**

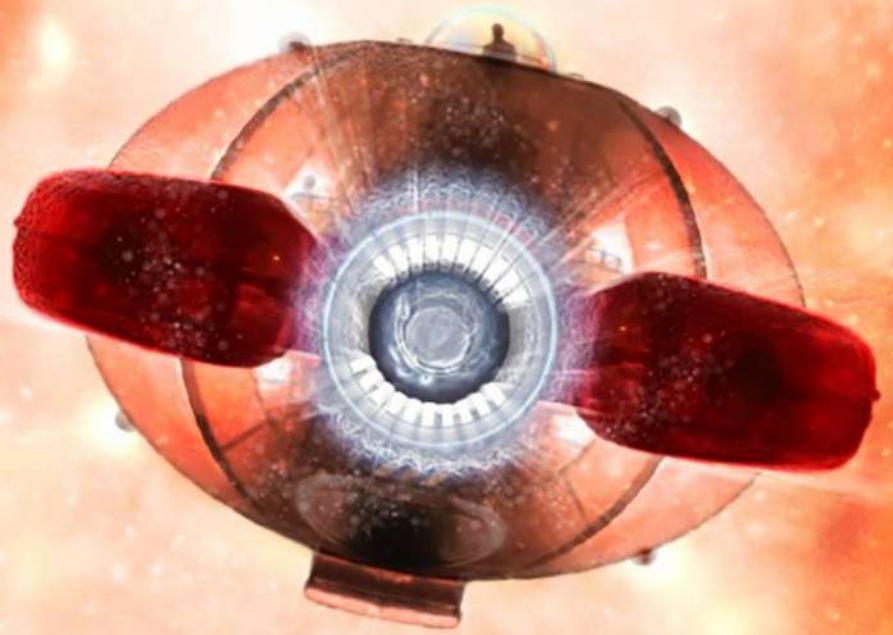

FANTASTIC VOYAGE

'When you can shrink and fly into the human brain it's amazing'

MEET THE DEV

TOMÁŠ BRNGÁL
VIRTUAL MEDICINE

in good health

'I was solving my own problem,' says Tomáš Brngál, remembering his medical student days in Slovakia back in 2014.

'I was preparing for an anatomy exam with the books and eye sections, and I was dreaming out how you could interact with the skeletal system, the muscles and the veins in 3D.

'Then I met a geek who was into VR and he showed me this technology and I saw it was what I was dreaming about. Now our software is used in 180 countries.'

At just 30, entrepreneur Tomáš is a qualified medical doctor and the founder and CEO of Virtual Medicine, one of many apps now available that promise to transform medical learning and practice.

He's gone from splicing cadavers fresh from the morgue to manipulating fully rendered 3D images of CT scans in VR.

'We used to carry two suitcases full of cables and powerful computers to do presentations and now we just take a Quest,' he says.

A bold frontier has opened up for high school students to learn about the human body in an innovative way and for medical professionals in surgical pre-planning. It's the new *Fantastic Voyage*.

'they are playing and educating themselves'

That classic sci-fi film from over a quarter of a century ago starred heartthrob Raquel Welsh shrunk to a microscopic size and injected into the human body in a tiny submarine.

'When you can shrink and fly into the human brain it's amazing, you can't do that in reality', ' laughs Tomáš, describing the Ant Mode feature of his flagship app, Human Anatomy VR.



It's a neat trick that brings an element of fun into learning.

You can do it in your own room in passthrough mode too and manipulate the whole thing with hand tracking.

'We also have an anatomical game with a story for kids.

'You are in an alien spaceship and your planet was destroyed and you find a perfect planet for living, the Earth. You need to understand the human body.

'They are playing and they are educating themselves', says Tomáš.

The simpler and cheaper version of the app (you can get a free trial for two hours) is aimed at sports and fitness enthusiasts or anyone with a passing interest.

The more detailed option with 10,000 anatomical structures is for medical professionals for education and surgical planning. And this is where it gets serious.

'surgeons are amazed when they see this'

'Surgeons are amazed when they see this. They can use it to prepare for complicated operations. We have special licensing for institutions and our newest innovation is DICOM models', he says.

DICOM stands for Digital Imaging and Communications in Medicine and is the standard for medical imaging from CT to MRI scans.

'You can upload any scan of your patient and our algorithm can do a complete reconstruction in 3D VR. Its a very specialised tool.

'The classical way is to see 2D displays in sections. But this is like the patient is there in front of you. They are cutting through the patient's virtual skin and bone and soft tissues in real time.

'Every innovation cycle takes time but eventually it could be standardised in medical practice,' he says.

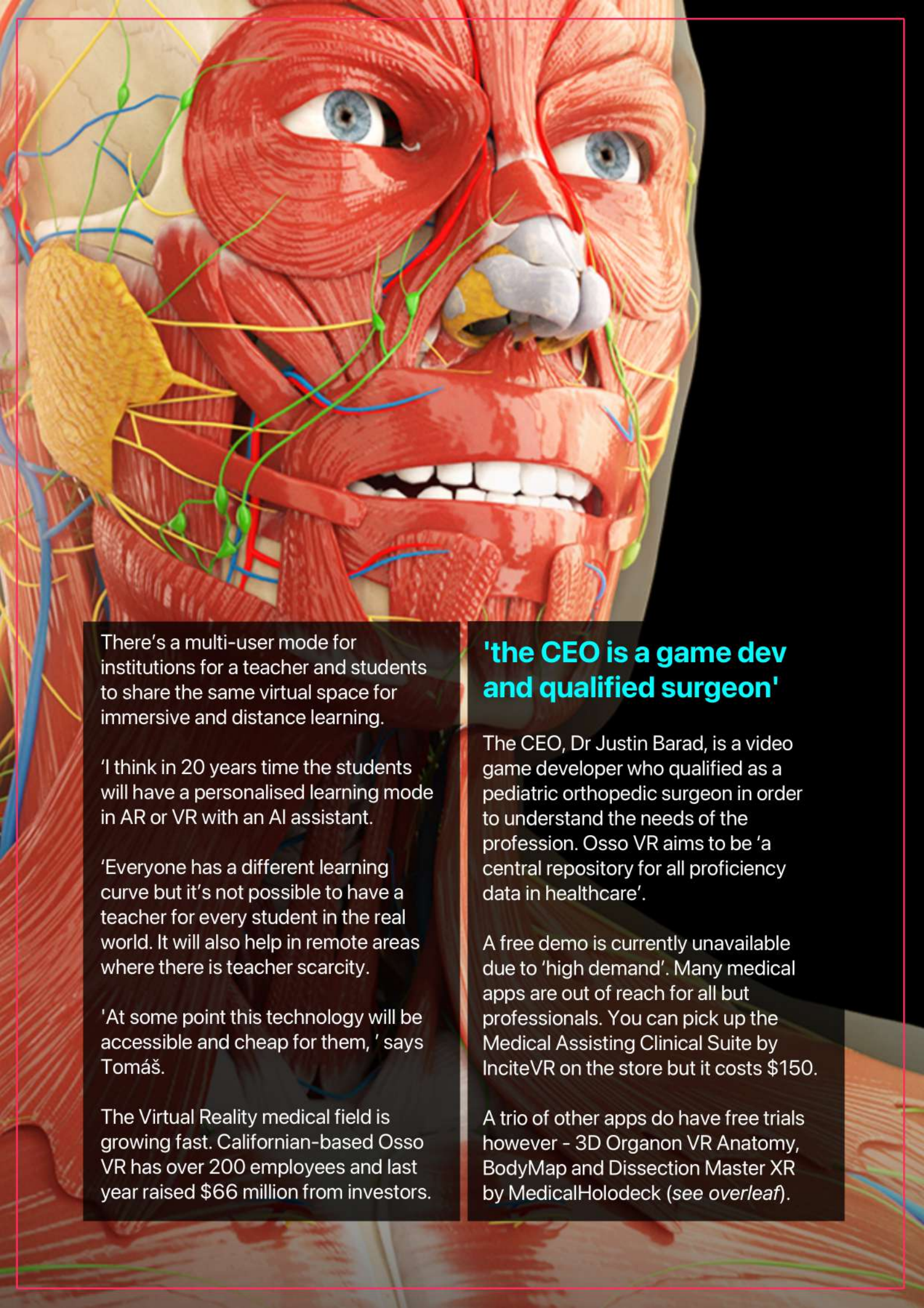

There's a multi-user mode for institutions for a teacher and students to share the same virtual space for immersive and distance learning.

'I think in 20 years time the students will have a personalised learning mode in AR or VR with an AI assistant.'

'Everyone has a different learning curve but it's not possible to have a teacher for every student in the real world. It will also help in remote areas where there is teacher scarcity.'

'At some point this technology will be accessible and cheap for them,' says Tomáš.

The Virtual Reality medical field is growing fast. Californian-based Osso VR has over 200 employees and last year raised \$66 million from investors.

'the CEO is a game dev and qualified surgeon'

The CEO, Dr Justin Barad, is a video game developer who qualified as a pediatric orthopedic surgeon in order to understand the needs of the profession. Osso VR aims to be 'a central repository for all proficiency data in healthcare'.

A free demo is currently unavailable due to 'high demand'. Many medical apps are out of reach for all but professionals. You can pick up the Medical Assisting Clinical Suite by InciteVR on the store but it costs \$150.

A trio of other apps do have free trials however - 3D Organon VR Anatomy, BodyMap and Dissection Master XR by MedicalHolodeck (see *overleaf*).

These apps are geared towards medical professionals and educational institutions but you can try them out for free

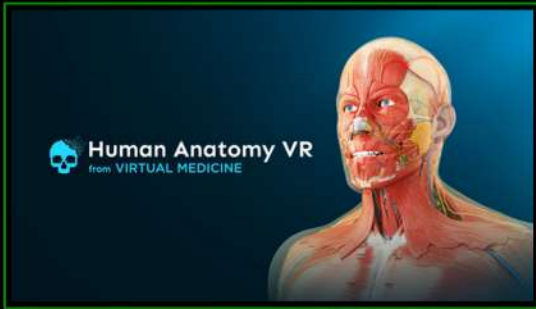

human anatomy vr 📱👁️
app lab | free (2hr trial)
 with ant mode!

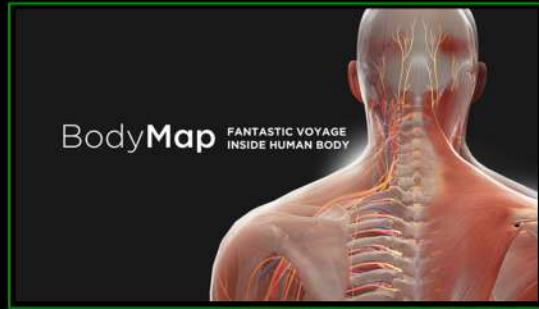

bodymap
mai.ai | free (14 day trial)
 fantastic voyage!



medicalholodeck
app lab | free (7 day trial)
 dissection master!



3D organon VR anatomy
app lab | free (7 day trial)
 micro anatomy!

And check out these other training and teaching aids



auscultation training
app lab | free
 listen to your body!



human osteology vr
app lab | free
 dem bones!



CPR
app lab | \$50
 save a life!



CPR simulator
app lab | \$10
 stayin' alive!



US army medical vr experience **app lab** | free
 M*A*S*H!



human anatomy puzzle
app lab | \$3
 skeletal exam!

'It's a profound experience to hold a human heart in your hands'

MEET THE DEV

TOMEK KUPIDURA
MEDICALHOLODECK

operating theatre

'For me it's a profound experience to hold a human heart. Before I could only imagine how it worked. Now you can hold your beating heart in your hand and just look at it and see how beautiful it is.'

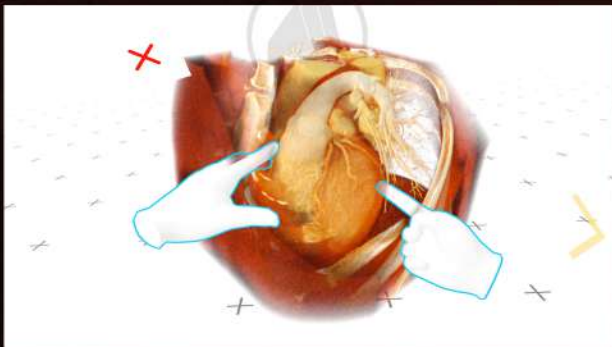

Tomek Kupidura from MedicalHolodeck is guiding me through the company's suite of apps from within the headset. He's represented by a pair of spectacles and floating green hands.

I turn the heart over in my hands, a surprisingly large organ, marvelling at the details. Could it inspire a whole new generation of medical students?

Tomek himself is clearly excited. He has worked in IT for 20 years but came fresh to the medical field eight months ago. 'I was able to learn more about human anatomy than in 40 years,' he says.

Medical Holodeck is a suite of apps - 'I like to think of it as a sandbox' - that are bundled together in the Cloud XR app.

Anatomy Master has a dummy male and female model and pre-loaded animations like the 4D beating heart and is aimed at the casual user and primary education.

The next level is Dissection Master, a real human body made with photogrammetry for university students which is available as a free trial for standalone Quest 2. It looks like a gruesome Goya painting or something out of Clockwork Orange.

'It's like a virtual cadaver lab,' explains Tomek. 'With a real cadaver the structures break down as more students make cuts. A virtual body removes this problem. It's not meant to replace an actual body but instead is a great complimentary tool. You will learn easier, faster and more efficiently,' he says.

The body is covered in blue dots that, when clicked, reveal info panels. You can open a browser window to cross-reference them to Wikipedia or any other site, or you can load jpegs or other 2D images.



'We have testimonies from medics who say 'this made me superhuman in surgery'

Lastly he shows me Medical Imaging XR, a professional level app for doctors for surgical planning. It's here you can load DICOM images and it's a place to teach or collaborate.

We are looking at a 3D render of an MRI scan of an actual patient's head. I can do a 'live cut' which splices at any point through the head so I can look at the brain. We are looking for a tumour.

'Every pixel or voxel is a representation of a particle in the space. I have filtered the unwanted tissues like bones to see through them. So I will remove the bones and the brain and be left with the veins and the blood. You can now see that there is a tumour here.

'Before you would look at 2D images one by one on a monitor.

'You get more information looking in 3D and you see the relation and I think this is the crucial thing', says Tomek.

We take a look at a damaged lung and a broken leg.

'You can make a movie or a photo or you can collaborate with someone on the other side of the world. Or show a patient what their diagnosis is and what is going to happen in surgery.

'I think we are just at the start of the evolution of VR and medical professionals can be skeptical and afraid of change.

'But there is a 'wow' effect every time I show this to doctors,' he says. 'They're amazed. We've testimonies like 'this made me superhuman in surgery.'



**LISTEN TO THE LATEST
PODCAST!**

EPISODE EIGHT
GO ON TOMAS & TOMEK'S
FANTASTIC VOYAGE
& INTO THE FUTURE OF MEDICINE!



**AD FREE! LISTEN [HERE](#), OR SUBSCRIBE
ON APPLE PODCASTS & SPOTIFY.
JUST SEARCH FOR 'GIBBY'S GUIDE'**



REVIEWED! GAMES & APPS!



interviews archive!

Download [this](#) supplement to read interviews with all the developers featured in past editions wherever you see **meet the devs!**



meet the devs!

**TALES FROM AROUND THE WORLD! SWITZERLAND | SWEDEN | ITALY
GERMANY | POLAND | BRAZIL | ENGLAND | JAPAN | CHINA |
HOLLAND | BELGIUM | ISRAEL | CANADA | SPAIN | WALES | USA**

best of the quest!



Red Matter 1 & 2 | \$25 & \$30

Spellbinding, eye-watering and jaw-dropping, Red Matter 2 is a great leap forward for standalone graphics that inhabit its own kind of rarified atmosphere.

It's as out-of-this-world as the fictional Volgravian base in which it sits, bathed in the glow of a magnificent Saturn.

This is sheer brilliance from the Spanish indie studio Vertical Robot and their art director Norman Schaar, dabbling in the dark arts to re-engineer the very coding tools at their disposal.

If it were just the best-in-class optics that elevated Red Matter that would be justified in itself but it's so much more.

This is a true heavyweight title, a spectacular sci-fi adventure set in an alternate future Cold War.

As Agent Epsilon aka Sasha, you are an astronaut isolated on an abandoned base in space, surrounded by propaganda in a pseudo-Soviet script.

In this game of psychological warfare chess, what's real and what is surreal keeps you guessing all the way to the end. What happened here? And who is watching your every move?

Moving around is a dream with jetpack bunny hops and you are equipped with extraordinarily well designed multi-tool gadget hands accommodating a torch, flares, claw, terminal hack, gun, storage and informational panel.

Almost everything is grabbable and often mesmerising in detail. The logic puzzles are finely crafted, not too cryptic but satisfying to decipher.

There's some adrenaline thrown into the mix with shooting mini games and there's even some remote-controlled fun.

It all comes together in an epic final battle that takes the breath away.

You don't need to have played Red Matter 1 to enjoy 2 but to miss out would be a shame. Taken together, it's a solid 8-10 hour campaign. Outstanding.



best of the quest!



Into The Radius | \$30

'Who is even giving me these missions? Why? I can't remember or understand a thing, yet here I am pressed to continue out here ... I've died once and yet the Radius lured me back in'

It's another of those handwritten notes scattered throughout the Radius, a found fragment of the story along with cassette tapes with field notes from previous explorers and the spoken memories of a white silhouette, Katya.

Brooding, dark, sinister, ethereal. Creepy, supernatural, oppressive, eerie. However you describe it, Into The Radius is genre busting - part horror, stealth and survival.

It's a vast Daliesque Dystopian world with train carriages mysteriously suspended in the air, monsters shimmering like echoes and that strange orange circle a constant glow in the sky.

Complex, deep and extensive, it strikes a balance between the exhilarating and the calm and from a desperate firefight to strumming the guitar back at your base and cleaning your arms.

The accurate rendering of weapons borders on the fetishistic. A sample loadout might be a Glock 18c pistol with red dot laser sight, an old OC-14 Grozna rifle with a grenade launcher found in the field and a trusty AKM upgraded with a scope for sniping.

But this is no shooter. Go in guns blazing and you'll never progress through the huge 40-50 hour campaign. The shadowy enemies collectively respawn with 'The Tide' every four days and four hours, forcing you to plan and prioritise as you take on mission after mission.

As Explorer #61, you are very much alone after the 'Pechorsk Event'. The world is populated with disembodied voices, noxious gases and crackling electricity - one of the disturbing anomalies presumably created by whatever scorched this land.

It's fantastic stuff from CM Games, a small studio from Tallinn in Estonia. The game has been out on PCVR since 2019 and it's clear it has had time to marinate and mature. The endgame doesn't disappoint either. An essential title.



best of the quest!



meet the dev!



Song In The Smoke | \$30

Sometimes VR can give you amaze-fatigue. And then once in a while an experience comes along that just floors you once more. That game is Song In The Smoke.

Living as a caveman you can hide out, making fires, drying pelts, roasting meat and planning your next attack.

It's an extensive survival simulator full of mythical and fantastical creatures. Collect three singing stones on each of the large-scale and luscious levels to enter a dream state and reveal mysterious ethereal animals.

With around 30 hours of game play, it's a wild world that takes you on an almost spiritual journey in a magical land.

Song In The Smoke is less of a game and more of a parallel existence, living alone against the odds. It's totally compelling and all-consuming.

With buttery smooth gameplay it is effectively an infinitely replayable pseudo-open prehistoric world.

Made with passion and soul by **Jake Kazdal** and the team at 17-bit, it's a vision that took five years to make.

'I wanted to create a beautiful, languid, juicy world to just walk around in,' says Jake. 'The game doesn't force you to do much. You could sit in one area and just hunt deer and make clothing, eat berries and watch sunsets.'

And then there's Savage mode, the tough as nails counterpart, a prehistoric ordeal of frightening proportions with the beasts - created by Japanese artist Katsuya Terada - ramped up to attack.

'I really wanted to play with these basic level instincts, with the fears and the triumphs,' he says.

And if that's not enough - 'you need to keep upping the dose to stay high' - test your mettle on the hardest: 'Jake' mode.

Only the developer and a half dozen dedicated gamers have reached this rarified mountain top (including yours truly!). One of the finest games on the standalone platform.



best of the quest!



Moss I & II | \$30 & \$40

'Your time has come at last, dear Reader' says the narrator as you open a dusty book in a candle-lit Cathedral. Here begins your bond with Quill, a young mouse, whose excited squeaks and cute high-fives will melt your heart.

She uses pantomime and even sign language to communicate as you navigate your hero through temples and castles. Sometimes you just want to stop and gawp at the beautiful scenery, so drop-dead gorgeous are the dioramas.

You control her in the third-person but can interact with the environment to help solve puzzles.

Moss Book II, the sequel to the much-loved original, sees the adventure continue in a longer campaign with new characters, mechanics and weapons.

And it's a truly magical journey from Seattle-based Polyarc. Puzzles are simpler and battles less intense than the original, but the scenography is even more breathtaking.

There's even a couple of real tear-jerking moments from your intimate emotional investment in a digital rodent.

As the adventure progresses her trusty sword can be swapped out for a giant hammer (an amusing weapon for a tiny creature) and a throwable circular blade that can boomerang back to her hand.

There are whole new environments that look and feel fresh. Incredible vistas open up that are worthy of any cinematic measure. Look close and you are rewarded time and again with thoughtful ornamental details.

From the epic final battle with the serpent at the end of the first chapter comes a new set of foes on an even grander scale.

And the story wanders into unfamiliar territory with perplexing perspective shifts and mirrors that add a welcome layer of complexity.

You can play Moss Book II without any knowledge of the original but you'd get half of some of the best VR has to offer.



survival games!



Green Hell VR | \$30

Swimming, building, bandaging and leech-pulling, exploring, hunting, munching and crafting, Green Hell takes you deep into the Amazon on a journey that slowly reveals itself through visions via the ayahuasca spirit medicine.

Choosing from 'tourist' to 'king of the jungle' (with or without jaguars and aggressive tribesfolk), it's an opulent and realistic survival tale, graphically as lush as the forest and impressively authentic.

I'm based in Brazil and can vouch for the veracity of everything from the jungle cacophony to the peacock-eye stingray pattern - but the tapir is a bit small for the largest land mammal in South America.

It's a tough gig playing anthropologist Jake Higgins, a constant battle against starvation and dehydration, poisoning and predators, all while free camping and fire lighting as you fight against the wild.

Play in story or survival mode and there's co-op multiplayer on the roadmap. See *substatica* on youtube for top tips!



The Walking Dead: Saints & Sinners | \$40

With a sequel on the way and two free updates (Meatgrinder & Aftershocks) under its belt, Saints & Sinners has put the flesh on a saturated zombie genre.

Dragging the apocalyptic New Orleans universe screaming into VR's front row, the developer's idea was to induce panic.

It's intense. It's gory. Your screwdriver goes through skulls. It squelches when you pull it out. You will feel fear. And if you hear the bells, run!

One of the few long campaign games on the platform, S&S combines a strategic survival system with brutal killing sprees wrapped inside an engaging storyline.

In many ways it sets the bar. The physics shine, the graphics are outstanding and there's an intricate level of interaction.

You can play the easier story mode or dive fully-armed into Aftershocks. There's a tonne of options - you can even select voice immersion. Now they can hear you.

stealth games!



Phantom: Covert Ops | \$30

In December 1942 ten British marines embarked on what has become known as the most courageous raid of WWII. They kayaked 100 miles at night to plant limpet mines on enemy German ships moored in France. Known as the Cockleshell Heroes, only two men lived to tell the tale.

UK-based nDreams cite the raid as the inspiration behind the phenomenal Phantom: Covert Ops. Stealth kayaking is certainly a unique VR experience - seven levels sneaking around in the pitch black infiltrating an old Cold War naval base.

There's a reach-over-your-shoulder machine gun amongst your arsenal but this is no shoot-'em-up - covert is key. A tense drama from inspiring origins with outstanding atmospherics.



Dead Second | \$20

Dead Second is all about the ingenious press and teleport mechanic which bodyshifts you to multiple predetermined crouching positions.

'Where is he?!' Take cover and take out the bad guys while you dodge their fire in slo-mo bullet time (the 'dead second') in this game of arcade cartoon violence with a pumping soundtrack. Quad kill! Monster shot!

There are now eight assignment levels, manual reloading, dual wielding and a firing range with the latest update.

From Australia's Sponge Games, It's an addictive high-octane shooter with some cool ragdoll death animations. One of the best of the genre.

République VR | free

An older title that has just become free of charge, République VR has you as the all-seeing eye helping to save Hope, a girl trapped in a totalitarian state. Third person camera angles and hiding in cupboards.

heart-pumping games!



Pistol Whip | \$30

Where else can you enter a pulsating arena taking out enemy assassins who are blazing ammo while dancing to the filthy electro of Black Tiger Sex Machine?!

An absolute monster of a must-have VR title, Pistol Whip is all about shooting to the beat in a unique cinematic bullet hell.

With 30 full-on tracks in arcade mode presented like cool movie posters, it's a high-octane trip. Vancouver Island-based Cloudhead Games delivers a visual art style that's polished and class throughout and they're always adding new content.

The Encore update delivers two new levels and a party mode to last year's Smoke & Thunder, a five-track campaign set in the Wild West.

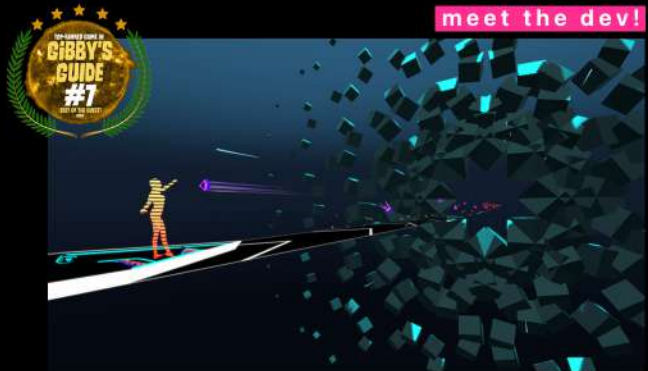

Audio Trip | \$15

One of the purest and most ecstatic experiences in VR, Audio Trip is an exhilarating choreographed dance experience.

Fly through a surreal universe, moving your body in ways you never knew you could - heart racing, feet dancing and arms making glorious arcs. The sweat, the adrenaline, the euphoria!

Developed by [Ashley Cooper and Brady Wright](#), Audio Trip has 84 hand-crafted choreographies from beginner through to cardio level. There's a great in-VR editor tool to make your own choreographies - follow the tutorial. Download custom ones at the unofficial Audio Trip Choreography Discord. Quality over quantity - and no money grab DLCs.

Gladius | \$15

'I'm Spartacus!' Comedy gore sword-fighting as you go from slave to Thunder God at the Colosseum in Rome. Slo-mo dismemberment! Cheering crowds! Lions! Tigers! Minotaurs! Sell heads in the market place! And still in Early Access!

grapple games!



meet the dev!



Yupitergrad | \$15

'Be careful, brave komrade Kosmonaut! Being a Slavic spiderman you don't fire silk but instead have some very Soviet-era red plungers. At least they seem reliable, and the suction cups give a satisfying 'plop' every time they land.

This is your only form of locomotion and you blast off to the 'top class space station' Yupitergrad to a stirring patriotic anthem. There are 55 fun cartoon-style levels to swing through, 40 more on time attack and a 'Gymnasion' play space.

It's all laced with delicious deadpan one-liners: 'Our crew gathers here to learn what they think' and the classic 'Breathe economically, never for pleasure'. Unique brilliance from Polish studio Gamedust, headed up by [Jakub Matuszczak](#).



Resist | \$20

Hear the whistling of the wind in your ears as you speed-grapple at night in the rain between the skyscrapers of the city of Concord, leading the resistance against Astra Robotics - tagline 'Keeping Humanity Safe From Itself'.

There's euphoric high once you get the hang of swinging, leaping and generally jet-packing around. Zoom down to attack giant drones and indulge in a bit of billboard-hacking as spy Sam Finch while comms chatter in your ear.

The flying can be a little unsettling at first but there's a huge range of comfort settings (try detached camera mode) from Australia's The Binary Mill studio. At street level the faceless populace remain blissfully unaware of their superhero.

Windlands | \$15

A port of a classic VR title, Windlands is one of the original swing, jump and run adventure games. Don't expect top level graphics from 2014, but the locomotion still feels great. Windlands 2, which adds archery combat and co-op, is due out.

'the matrix'-style games!



Bang Bang Slice | free

Any prototype game that looks like Pistol Whip and plays like Superhot is gonna be worth checking out and solo developer Zander Dejah has attempted just that.

There's a time limit on each of the 30 plus levels which require strategic thought as much as fast reflexes.

With each move you swap places with the enemy and take their weapon to kill the next. The trick is to decide which one to take out first.

Innovations like curving bullets have been added to the dozens of weapons among your banging and slicing arsenal.

Scenes are inspired by classic action films, like Wanted and I Expect You to Die.



Superhot VR | \$25

With over a million copies sold over five years, Superhot is a true VR classic. It's The Matrix made real - time only moves when you move.

Featuring minimalist white environments, red polygonal people made of glass and unique gameplay, you are outnumbered and outgunned.

From airport terminals to subways, you have to punch, shoot, stab and smash your enemies with ashtrays, bottles, throwing stars, billiard balls - and guns. Finishing the short campaign unlocks endless mode.

Last year the developers decided to remove suicide and self-harm scenes, saying 'we regret it took us so long.'

Agent Simulation | free demo

A challenging Superhot clone that is not without its faults but it's a fun free alternative when you are looking for some more Matrix-like action. Dodge and shoot through scenes from the movies.

flight sim games!



Ultrawings 2 | \$25

Ba-boom! It's only when you take out your first enemy on an ops mission that you realise this is a hell of an upgrade.

Yes this flight sim still has the same cutesy cartoony graphics, target rings to fly through and airports to buy, but this is all about the amazing dogfighting. The addition of multiplayer takes it to yet another level.

There are four new planes and a Dragonfly helicopter to pilot. Once you've got used the handling and have done your basic training you'll quickly move on to the Stallion and those guns. A big game with tonnes of missions.

*** Ultrawings 1 is also available priced \$15**



Warplanes: Battles Over Pacific \$15

From the hand-thrown bombs, flares and a machine gun prone to jamming from the Great War comes the technological leap of World War II with faster, sleeker and deadlier battles in the skies.

A mix of arcade and flight simulator (with tweaks in-between for motion sickness comfort controls), Waplanes sees you fighting against the Empire of Japan.

Home Net Games deliver outstanding graphics as you perform heroic dogfights against fighter squadrons in a single campaign or multiplayer with PvP and co-op with ten iconic aircraft.

*** Warplanes: WW1 Fighters is also available priced \$20**

Simple Planes VR | US\$10

Simple Planes is an odd name for a game that's neither easy or restricted to aircraft. If you can pilot, drive or ride it, you can find it. Helicopters, boats, scooters, buggies, tanks, jeeps, sci-fi spacecraft - there's even a mechanical monitor lizard.

horror games!



meet the dev!



Crashland | \$20

Aaaaaarrrrrrrgggggghhhh! That's the sound of both terror and frustration as you perish once more from another brutal onslaught of giant hellworms, vicious waves of squealing pig burrowers and a relentless blitz of bloodsucking ticks.

Crashland is played in frenetic intense bursts on alien worlds until some unseen Scotty beams you up to safety. The relentless nightmare continues as you learn teleporting tactics, unlock perks and figure out how the hell to survive. Fire into the sky to get turret support and level up to hellfire and the funky boomshot!

It's far from easy but the relish is in the challenge. There's 24 finely engineered levels. From the evil genius of Welsh developer [Llŷr ap Cenydd](#).



Lies Beneath | \$30

Far from being yet another zombie slasher, Lies Beneath is a graphic novel thriller wearing suspense and surrealism in its finest comic book garb.

It begins with the aftermath of a car crash and quickens the pace with a chase before you start to pick up some weapons to begin to defend yourself against the mysterious unknown in Slumber, Alaska.

Use your Zippo lighter to burn glowing voodoo dolls, pinpoint where to shoot and guide you through the darkness.

The story reveals itself through text bubbles along the 20 creepy chapters. More atmospheric than jumpy, but with enough horror to recoil in this cel-shaded yarn. From Seattle-based dev Drifter VR.

Cosmodread | \$15

Set on a dying spacecraft, Cosmodread is a moody maze of strategy, stealth and cunning with surprises behind every door. Ethereal and terrifying, it's another hit from the solo Spanish developer Sergio Hidalgo, creator of the classic Dreadhalls.

back to the '80s games!



ARK-ADE | free demo | \$10

Are you ready, human? With Pistol Whip vibes, ARK-ADE is a beautifully polished FPS - a love song to 80s arcade games.

Glance to the right on any of the blue and purple neon levels and you'll see that you are inside the actual cabinet. Those cool touches set ARK-ADE apart.

It's got a clever dynamic of having 'ARK', a spinning cube whose health is linked to yours, as you blast through Tron-like enemies to an ear-worm soundtrack.

First-time devs Castello Inc refined the game along with the community and it shows. And they keep adding new levels for free. Make sure to turn on the 'Italian taste' option - 'Bellissimo!' 'Bravo!' 'Mamma mia!'. Eccellente.

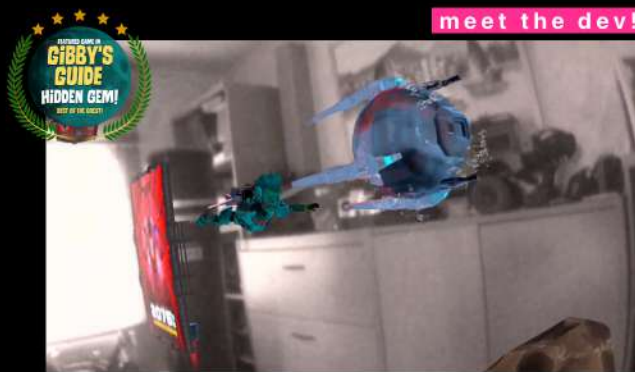

2076 Midway Multiverse

free demo & in-app

Ivanovich Games have a habit of VRifying side-scrolling shooters and *2076 Midway Multiverse* is their latest nostalgic and humorous take on the old skool games.

There are also some insane perspective shifts, from pancake to X-wing Star Wars fighter-style immersion and back again.

But one of the most impressive aspects of the game is an incredible passthrough experience.

'I thought that the idea of having toy ships floating in my room could work and I felt the need to try it,' says **Ivan Cascales**, head of the Barcelona-based studio. 'When we tried it, the 'wow' came out that puts a smile on your face.'

Galaxy Forces VR | free

With a cool and all-too-rare 'sky view' option for playing while horizontal, *Galaxy Forces VR* is a wet dream for old skool arcaders. Nudge, nudge, nudge the thrusters of that little red triangular spaceship to land. Tink!

roguelite games!

*see glossary!



Ancient Dungeon | \$20

Never has a pixelated wailing zombie ever felt so threatening. Solo developer Eric Thullen even has a content warning: 'contains blocky dismemberment and blood'!

Go further with each run into the dark randomly generated dungeon, armed with a sword and throwing dagger against evil poison-spitting plants, bats and jumping bushes in the Overgrown Gatehouse, on to the fire creatures of the Forgotten Library, the Luminous Mines and beyond.

Smash everything, pick up loot and power-ups, and be prepared for a lot of close combat. 'Crush capitalism' is listed as one of the game's milestones. Might take a while.



Sweet Surrender | \$25

Sweet surrender has got the perfect dose of sugar-coated something that just keeps you coming back for more.

Amidst gorgeous cartoon cel-shaded graphics, you stick it to the machines armed with everything from a kick-ass adrenaline stick to a sawn-off shotgun.

With constant updates since launch by Munich-based indie Salmi Games, it's fine-tuned and fast maturing into a sleeper hit. Play as a rebel, medic, sniper, grenadier or lunatic.

Dash from room to room, zipline across lava and grapple up walls as you upgrade inch by inch with run-to-run progression. Kudos for the music design and cues in this funky futuristic title. Brilliant.

Directive Nine | \$13

A great moody sci-fi shooter set on a spinning space station with surprises behind each vertical sliding door, 'D9' is fiercely addictive. Weapons - from taser-like photon neutralizers to a quad pipe - carry over and no run is the same.

rock rhythm games!



Unplugged: Air Guitar | \$25 & dlc

A poster child for hand tracking technology, Unplugged takes the air guitar to its natural conclusion. If you've ever played Guitar Hero you'll know the sketch, lining up your fingers to the flying colour-coordinated chords.

The sensation of holding an invisible guitar in your hands is incredible. Vibe with the audience doing the sign of the horns and you'll even get panties thrown at you - get it wrong and you'll drown in boos and tomatoes.

Satchel from Steel Panther will guide you on your journey from playing dives like Satan's Whiskers to being a rock God on stage at the Mercury Arena. There's 25 tracks from The Clash to Ozzy Osbourne. Now with passthrough!



Ragnarock | \$25 & dlc

A quick wave of your huge hammers to your rivals left and right, an 'Ah-Hoooo!' with your fist-waving troops and off you go on a mental rhythm race in your Viking ship to some crazy Celtic tune.

The premise is simple, just hit the four drums in synch with the runes as your crew rows you through Scandinavian mythological scenery or into the Hellfire festival! The trick to going faster is all about getting your combo bonuses by hitting the shields to the sides.

There's solo mode but Ragnarock really comes alive in multiplayer, as up to five other boats line up in a chase of the longships. There's 32 head-banging tunes and it even supports custom songs. A classic party game. 'Ah-Hooooooo!'

GrooVR | \$15

There's something about Brazilian death metal that will you up out of your virtual seat! GrooVR is arcade fun air drumming to 38 songs with an adjustable kit and the familiar flying patterns to play along to. From São Paulo-based Infinity Dreams.

tower defence games!



Invaders Galactic Defender | \$15

'Are you ready to space exterminate?!' Here comes another wave of those high-pitch screeching speedy orange bugs and monkey-faced Brawlers. Better load those turrets and get your pistol and bow-and-arrow ready fast!

Invaders is an intense arcade tower defence game set on rich cartoony planets, from the waterfalls of the New Era crystal lake to the hellscapes of Dante.

It's a relentless but fun shooter as you teleport from tower to tower, saving your killer over-the-shoulder laser against that last-second breach. An unseen voice urges you on: 'Ohhh what a show!' Back at the hub your kills are displayed in glass jars. Nice touch. An overlooked title from French studio Aiko.



Guardians | \$20

'The Base Is Under Attack!' Guardians is a unique fusion of strategy and shooter and you start as a cadet for the Galactic Federation (Est. 2690) on the desert world of Titan. It's just you and two combat droids against the aliens.

The Federation are mining energy crystals and you must defend against the space bugs with an insane variety of weapons and defences. Spawn turrets and tanks and use your gravity gun or mind-control grenade as you teleport and jetpack around the three planets.

It's got the full gamut - single player, or multiplayer co-op or pvp. Fast Travel Games have snapped up the title and it will be re-released on the main store as Guardians Frontline.

Iron Guard | free demo | \$15

A roomscale tower defence game where you can move around the sci-fi scenery from greens to desert, winter to lava. You can build and upgrade but you are also an active shooter when the waves begin from the ground or the air.

pvp multiplayer games!



Eleven | \$20

This is some serious ping pong club. With 600,000 registered users, Eleven table tennis now hosts well over a million monthly multiplayer matches - that's almost 50,000 a day.

One of the world's leading sports simulators, it also has an incredible AI for solo play that goes from Easy to Legend.

'There are no tricks. This *is* table tennis,' says **Roman Rekhler**, co-founder of New York-based For Fun Labs. Clever illusions that shave milliseconds off the latency of the game means you can play from New York to China in real time.

Climb the rankings and enter official tournaments. You can watch the finals and some expert tutorials on youtube.



Blaston | \$20

3 ... 2 ... 1 ... Blaston! The genius of this duelling multiplayer that it is mute, creating the social mimes of bowing, waving and fist bumping as you face off like gladiators on neon podiums in front of a cheering audience.

It's like a non-aggressive fight with an array of toy weapons that deliver slow motion scatter bombs and splats. You need both tactical quick-thinking and premeditated skullduggery as you chop and change your arsenal of big pink balls and ice lasers between matches. It's deceptively energetic.

Resolution games continue to innovate - there's an amazing passthrough mode, a single player mission and wild west quick draw duelling!

War Yards | free

The ace in the hole here is the slo-mo matrix-style 'bullet time' as your foes recoil as ragdolls! There's the fort, the mine, the train and now even 'Sand Hill' Cemetery, inspired by The Good, the Bad and the Ugly. Gunslingin' guffaws!

social multiplayer games!



Real VR Fishing | \$20

It could be the cherry blossom falling into Lake Hosan as you cast the line. Or the rain falling as you fish from your boat in Chungju. Or a rainbow over the River Han as you chase minnows.

Whatever it is, everyone seems to fall in love with the simple bliss of Real VR Fishing. Yes, of course there is the drama of trying to land a mako or tiger shark, but it's the sheer tranquility of the photorealistic scenes across South Korea, the US West and Japan that make this game special.

With a myriad of freshwater or saltwater locations and lure or float, you can fish with friends, compete in the seasons and listen to your own music. Chill out back at the cosy lodge.



Walkabout Mini Golf | \$15

Whether it's out of this world at Tethys space station under Saturn's rings, or bumbling around a rainy graveyard in Original Gothic, this is the craziest of crazy golf.

Consistently rated as one of the best multiplayer games, this gem from Texas-based Mighty Coconut delivers a variety of gorgeous courses to idly wander around as you putt and chat. New courses are being added at \$3 a go.

Find hidden balls or score 10 under par to unlock harder modes with added 'foxhunt' mysteries to solve!

And you can even aim your club straight up and soar like Mary Poppins above the greens to get a bird's-eye view. Fore!

Black Hole Pool | free demo | \$10

Pixel Works' excellent pool sim finds you in a bar ready to rack 'em up and play AI, randoms or invite a friend. There's a giant screen for youtube or just listen to the ambience. Easy to pick up and incredible physics. APA rules.

more social multiplayer!



The Under Presents | free

I enter the lobby and a band, 'The Lame Drivers' - led by a giraffe - are playing. Someone hands me a blue flower. I cast a turnip spell and return the favour.

This is magical, theatrical world of 'The Under Presents', and we are mute black gowned sprites with golden masks. This voiceless multiplayer communication begs for mimes, finger-clicking, bows and courtesies and has incredible spacial interaction.

Tender Claws have created a piece of art with the amazing scrunch locomotion technique, essentially warping through space. The demo has over 30 minutes of single player mysteries to discover. Other adventures, like The Timeboat, are available for a fee.



Ultimechs | free & in-app

Resolution Games are betting on VR sports. Ultimechs is the latest offering and like Blaston before it there's no voice chat to avoid the toxicity that plagues so many multiplayer games (but you can switch it on for friends).

Choose your mech from Titan, Viper or Nitro - each one has specific powers - and enter the simple arena for 1v1 and 2v2 battles where you use swervable rocket-powered fists to score in your opponent's goal. It's fast, fun and easy to pick up and play.

Unlike similar titles there's teleporting instead of free movement (perhaps in a bid to counter motion sickness) but the pace is just as frenetic. It's free but the cosmetic 'Ultipasses' cost up to \$50.

Tower Tag | free

With a bodyshifting teleport mechanic to move through the rooftops, Tower Tag is a fast-paced multiplayer game of laser paintball. You'll need to move physically to hide behind the towers so make sure you have some space.

co-op multiplayer games!



Mothergunship Forge | \$20

Mothergunship Forge is a wave shooter where you build bespoke guns and weapons which get bigger and more ridiculous as you go through your run.

It's a simple premise from Terrible Posture Games. Bolt on whatever new bit of kit gets thrown at you and soon you'll be double wielding with multi-angled mad machines.

It's a die-and-you-start-again job but there are permanent upgrades to keep you coming back.

In addition to single player, sandbox, endless and co-op campaign have all been added since launch along with tweaks and new enemies - always a good sign from active developers.



Vox Machinae | US\$25

H.G. Wells first imagined 100 feet tall gigantic Martian fighting machines back in 1898. Now you can pilot your own.

There's nothing quite like jet-jumping around alien landscapes and feeling the bone-crunching weight of your rust bucket as you try and take out a dozen others doing the same.

Pick your 'Grinder' - Goldrush, Hopper, Dredge, Catalyst, Rook, Drill, Overhaul - arm yourself to the teeth and dive in.

With up to 16 simultaneous players at once, you can VOIP via an old skool walkie talkie while your customised avatar appears on webcam. Best to skip the painful single player campaign, though.

Grapple Tournament | \$15

This stylised cartoon style arena shooter is a blur of swinging, springing, parkour, climbing and running in a vertical combat. There's seven maps and a dozen weapons in multiplayer from melee blade to rocket launcher.

vr and non-vr multiplayer!



Carly and the Reaperman | \$20

Our green-haired heroine Carly arrives at Sunrise Avenue train station. She hops off on to the platform. Your massive grinning skull looms into view and your huge bony digits dwarf her tiny hands. You fist bump.

Developed by Odd Raven studios, it's a genius concept. The game is optimised as a two-player remote online co-op where one plays Carly on a flatscreen PC or mac while the other is the Reaperman in VR.

Aside from dressing up in comedy wigs, the Reaperman must employ blocks, torches and switches to help Carly as she navigates this fiendish 50-level platformer set in the supernatural world of the dead.

You can play on two Quests too or as a single player - but that's not half the fun.



Acron: Attack of the Squirrels! | \$20

An oldie but a goodie from Resolution Games, Acron is an asymmetrical family party game. The player in VR is an old tree, defending itself from the animal creatures (others on phones) intent on stealing the golden acorns.

A minimum of one is needed to play against the tree but you can add up to another seven bots or people.

Each player has a different power - a squirrel can run, a beaver can build - as they lay siege, defending themselves with pumpkin shields or an Indian headdress. At ground-level it's a complicated terrain, whereas the tree has the advantage of height. It's a take-it-in-turns affair to be the tree and lots of really silly fun.



Do You Copy? | \$13

In VR you are a thief wandering around a pretty unsecure bank, blind to the dangers. On a mobile your cohort is your eyes and ears with a floor plan to guide you past guards and security cameras. Find the safe together!

sports games!



The Climb 2 | \$30

In this sequel it's the city skyscrapers that take top billing - a totally different experience to the stunning landscapes of the Alps, Bay and Canyon levels that came before (and are updated here).

But it's the frozen wastes of the North which are perhaps the finest challenges. Creaking ice, a howling wind and chattering puffins accompany your ascent - in casual or professional mode.

Throw in a family of polar bears and an Arctic wolf prowling around an abandoned airplane and the experience has really reached its dazzling pinnacle.

Developers Crytek have added rhythm challenges and more in two Freestyle Expansion Packs.



Holopoint | \$15

With its origins in the samurai of feudal Japan, Kyūdō is the martial art of archery. Holopoint, from Florida-based Azlan studios, arms you with a bow and arrow against holographic projections of blue sword-wielding and orange star-throwing ninjas.

Dodging and ducking, it's a fierce workout with squats burning your hamstrings and glutes. You begin in a minimalist dojo shooting cubes and shapes who fire back when hit. Drawing back to your cheek allows you to quickly reload from your quiver by reaching over your shoulder. Listen out for aural clues.

There's a zen Garden Update with 30 extra waves. Checkpoints are at every five levels. Warning: intense!

First Person Tennis | \$23

An established simulator, FPT finally arrives on the Quest with fine physics and great commentary. There are five motion options depending on your space, plus arcade or simulator modes, multiplayer, seven court surfaces and a world tour.

more sports games!



Carve | \$20

Come into the cosy log fire cabin with your golden labrador puppy, a radio with snow reports and some old skool mixtapes on cassette. Choose your gloves and your board and you are ready to shred the powder!

Carve is a lovely, intuitive arrival on to the slopes. Crushy snow sounds, squeaky gloves. And then ... go! Flying over mumps, skidding over handrails, dodging rocks and snow-laden trees, you career down the mountain at exhilarating speeds. In time attack that's the objective - to unlock more levels from forests to caves and a new night mode!

Or you can go freestyle, then it's tricks and flicks. From the creator of 1080 snowboarding, published by Chuhai labs.

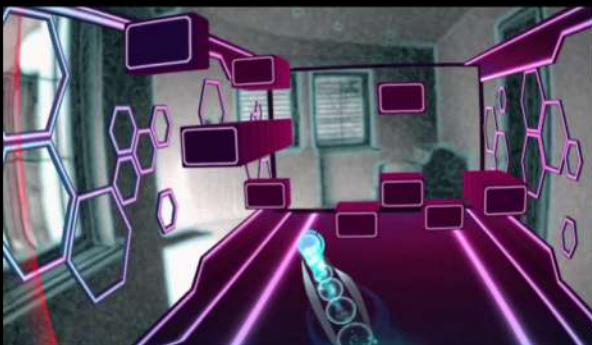

Thrill of the Fight | \$10

The undisputed heavyweight champion of boxing games, this is a serious workout in a down-at-heel gym.

It's a visceral affair with cuts and nosebleeds as you fight your way through the nine opponents to reach the championship arena.

A true room-scale experience, you'll be bobbing and weaving against bruisers like Ugly Joe, Duke and the Moneymaker. Real-life pugilists attest to the game mechanics as the real deal and there are bonus rounds against a zombie, a headless boxer and a ghost.

There's an exciting multiplayer sequel in the works from Sealost Interactive aka solo developer Ian Fitz. Knockout!

Cybrix | \$10

A frantic mix of Breakout and squash inside a neon rectangle, Cybrix is a proper arm workout. Play through a 50-level campaign using powerballs and multiballs to smash through the blocks. Plus passthrough in endless mode!

even more sports games!



V-Speedway | free

Buckle up for some arcade racing around Shanghai-esque city streets in this smooth driving game with lovely handling and drifting physics.

Italian dev Danjel Ricci named his studio Commuter Games as he says the journey to work is the only time he gets to develop on his 2013 laptop. His labour of love has now been downloaded over 500,000 times.

Go single race, time attack mode or free ride on multiple track layouts with AI drivers and competitive online leaderboards.

Look out for its direct successor, Downtown Club, coming later this year with multiplayer and more. Top gear!



meet the dev!



Crazy Kung Fu | \$10

The pioneer to use passthrough was Crazy Kung Fu, allowing you to arrange digital assets in your room to build your very own dojo!

Pitted against a spinning Wing Chun wooden dummy, you must dodge flashing blades, block and punch as you train under the wise man's watchful gaze. Can you be quicker than the human eye?!

Solo developer **Arnaud** from Shanghai-based Field of Vision originally designed CKF for his own training as a practitioner of martial arts for 12 years.

There's even the option to have falling shrimps to munch on to test your reflexes! To get passthrough mode go to the game's menu, choose extras > MR.

The Final Overs | free

Despite having a couple of billion fanatical fans globally, cricket is sport unknown to many. Get ready to be bowled over by The Final Overs, a passion project from the heart of one of the biggest cricketing countries, Pakistan.

yet more sports games!



Nock | \$10

A cross between archery, football and ice-hockey set in a minimalist stadium, Nock is a new VR sport from Normal studio with an already dedicated fanbase.

Fast-paced and funky, you glide or fly around the court trying to score in your opponent's goal in 1v1, 2v2 or 3v3 games, armed with a bow and three arrows. Shoot the oversized ball and you get an arrow back (or pick up packs) and dribble if you run out. You can create stripy boxes to block shots.

Get ready to be slaughtered on your first run outs and make sure you switch on the reticle in the in-game menu for aim. You can pull yourself across walls and the ceiling. It's highly addictive once you get the hang of it. Goaaaaaaaaaaaaal!



Blacktop Hoops | free demo

This is the future of VR basketball and rapidly becoming a go-to sports title. Finally, fluid mechanics that just work. Instead of you holding the ball, it sticks to you - clever. Dribble, shoot and even do crossovers between your legs.

Physically turn in place to execute spin moves and you can even hold on to the rim with a double-grip press.

Play multiplayer with the Online Parks update with games of up to four people from scrub to pro or practice against the AI in NYC. There's also comedy 8 foot and big head modes.

It's got a fresh cool art style, tunes and roasting commentary: 'You making that net like a noodle factory!' Slam dunk!

Racket NX | \$20

Mad futuristic neon-lit geodesic dome? Check. Wacky new squash-breakout fusion with tractor beam? Check. Your own music and level design? Check! Now ratified as a new sport by the International Racquetball Federation!

parkour games!



Stride | \$15

Parkour is really about the ultimate fantasy getaway escape route and Stride delivers to an edgy deep bass soundtrack as you leap across the rooftops.

Executing a wall run while gunning mid-air in slow motion feels good! This is parkour with pistols, climbing and cat leaps, swinging from hooks and flying down zip lines. All while trying not to get killed. It's a physical game - you swing your arms to run, throw them up to jump, push down to vault and crouch to slide.

In endless mode you get chased by an advancing red line as a minimalist world disintegrates behind you. Time attack is for speed runs, while arena mode has the proper cityscape. Creators Joy Way have now added multiplayer.



No More Rainbows | free demo

With a Gorilla Tag-style movement to physically run, jump and climb, this platformer from Canadian-based studio Squido is an impossibly colourful universe - and it's your mission to destroy and desecrate it.

You play The Beast, the Warden of the Underworld, who awakes to find their world has become a disgusting sweet-smelling rose garden of glowing princesses. Wipe the smile off their faces and begone thy infinite joy!

Pulverise their picturesque picnics! Mash their pink-hearted teapots! Crush their perfect picket-fenced playgrounds!

The final release promises four unique worlds and multiplayer.

To The Top | \$20

To The Top is a platformer with an incredible amount of freedom of movement. Gaze and leap, fly and climb. Use monkey bars, grappling hooks, shuttles - the crazy movement mechanics are a joy in this older experimental title.

self-cloning games!



We Are One | free demo

We Are One is a solo multiplayer - a co-op with clones of yourself! Formerly known as Help Yourself, it was the first example of the genre for the Quest and currently available as a demo.

A puzzle shooter, it's mesmerising watching replays of yourself playing alongside your current self in a surreal time-bending bond.

With a fun scrapbook cut 'n' paste art style, it's the leaf people (you) against the machines. Pre-load your green guns with seed-like bullets and toss it to yourself to be ready in the next time loop.

The trick is to figure out the sequence of events while avoiding being hit by the robot's ninja stars. As you progress, so do the number of clones and complexity. There are half a dozen levels to play beyond the tutorial.

Made by Flat Head Games, five Masters students at Salzburg University in Austria, it's now been picked up by Fast Travel Games. The full version will be released later this year.



The Last Clockwinder | US\$25

When you are dancing because you've managed to get a blueberry onto a stick, and then discover that that dance is now replicated by your clone - that's when you realise just how much fun The Last Clockwinder is.

You could create a whole fruit juggling circus troupe if you wanted to, but the aim of the game is to create a chain of gardening copycats using your own movements to restore an ancient tree.

The centrepiece of the cartoon lab is an ever-changing set, each level a new puzzle. You set your automotons to work, tossing *luftapples* and *bomb berries* around with abandon.

Get your juice production line in order and then create 'molecules' (fruit stuck together) to get seeds to plant more. Stand back and admire your handiwork from the balcony.

There's 25 levels and an incidental backstory but plenty of replayability. From Pontoco, a games studio based in San Francisco and New York.

escape room games!

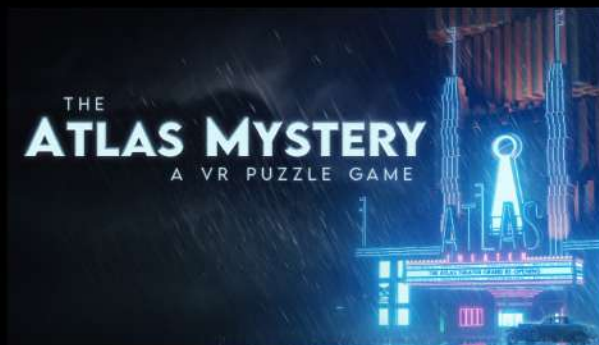

The Atlas Mystery | \$15

An abandoned movie theatre, spooky music and a murder mystery - it's Hollywood in 1951 and you have to figure out what drama has befallen the Atlas.

Drawing on classic escape room fare of codes and puzzles, there's soda and popcorn to serve to no-one, a vast hall dominated by a globe and a film projector that needs a fix.

There's plenty of 'a-ha' moments as you piece it together bit by bit, an hour or two of searching and solving.

You have a backpack to gather random objects from screwdrivers and statuettes and there's an ever-present unnerving sense that someone or something is about to make you feel less than alone.



I Expect You To Die 1 & 2 | \$25 x2

This sequel to a much-loved older puzzler, The Spy and the Liar delivers six fresh new fiendish escape rooms.

Still as a 007-style secret agent with seemingly unlimited access to cigars and champagne, your mission is to stop Zoraxis plans for world domination.

As a theatre hand in Operation Stage Fright to the Operation Rising Phoenix finale, you will perish repeatedly but the difficulty level is perfectly weighted to push you all the way to a triumphant solution. The nod to spy films and voice acting is top class with a warm humour throughout. Welcome back, agent!

*** I Expect You To Die 1 is also available priced \$25**

Extreme Escape | \$5

You've got 45 minutes to repair and land your hot air balloon. You are losing height and leaking air. You'll need some room to move around but you can press A or X to teleport in the cabin. Then get out and climb the ropes. Not for the vertiginous!

world building games!



Deisim | \$15

World-building lends itself wonderfully to VR. You can fly across your domain in seconds, inspecting individuals and crushing heretics. Or pull out into a wide angle, cackling with evil intent or altruistic endeavour - it's up to you.

Deisim sets you up as an all-powerful God, destined to lead humankind out of the stone-age and into the future. You create biomes with a nonchalant flick of the wrist and watch as the Egyptians begin building golden Pyramids in the desert oasis or African villages emerge.

It's spellbinding to watch the progression of civilisations but you are not alone - watch out for the UFOs ready to decimate your carefully constructed universe. Now on the store with a vast Kingdom update!



Little Cities | \$20

Little Cities is a homespun world builder from husband and wife team James & Kelly, a gorgeous chilled out experience full of delicious little touches from spouting whales to hot air balloons.

Aside from your common or garden buildings and utilities you can unlock all sorts of goodies, like a moral-boosting aquarium or a rocket testing site.

It's beautiful and benign - give or take an exploding volcano - as you zoom down to street level and marvel at your island creations bustling with life.

A joy to play, it's an exercise in executing the perfect user interface either with controllers or hand tracking. The attractions update added style ratings.

Townscaper VR | \$10

Lovely and pointless, relaxing and creative, Townscaper VR is city-building like doodling. With a calming vibe you can make your pretty cities effortlessly. Developer Oskar Stålberg describes it as a toy more than a game.

space strategy games!



Eternal Starlight | \$20

Tactical space combat, now with an optional permadeath mechanic, Eternal Starlight is a complex beast but you can sit back and control all the action with full hand tracking support.

With seventeen capital class vessels to choose from, equip your ship, bring up the starmap to choose your mission and open the 'neural link' to battle with a range of alien entities at any scale.

We've destroyed the Earth (again) and have to defend our new home, Proxima, with the help of guinea pig-like allies.

White Noise Games have added a new Endless mode, a procedurally-generated campaign, and a skirmish mode for custom battles.



BattleGroup VR | \$25

A space fleet command strategy game in real time, Battlegroup VR centres around a gorgeous holomap as you stand aboard your craft directing the action.

A satisfyingly huge wheel sits in the middle to navigate as the battle rages outside the cockpit. You are not just a commander in chief but also an active participant.

Choose and train your captains through a dozen missions in single-player, co-op or multiplayer. There's an impressive depth and beauty and a huge variety of customisation.

Still in Early Access, it's the labour of love of solo indie game dev Ken, of Spaceowl studios.

Gods of Gravity | free

With up to 8 players this is a sleek and polished strategy game with a dedicated non-toxic fan base. Capture nearby planets - and even the sun - and last God standing wins. There's a single player campaign too.

adventure puzzle games!



Down The Rabbit Hole | \$20

The unique and astonishing perspectives of the theatrical dioramas put Down The Rabbit Hole in a league of its own. Hold the writhing roots and you can twist the scenery around at your will, even pulling it to your eye like a giant inspecting a tiny fantastical world.

But it's not the only jaw-dropping aspect of Cortopia studio's tale, as you guide 'Elise' around a prequel to the Adventures in Wonderland with her side-kick, the four-and-a-half of spades. It's the intense attention to detail, like the words on a pot in the kitchen or the smoke billowing from The Caterpillar's opium pipe.

Levels like the mirrored Winter Lake are a showcase of puzzling ingenuity. You just never want the magic to end.



The Room VR | \$30

It's 1908 at Bloomsbury Police Station in London and an archeologist is missing. As a detective you have to solve the mystery by collecting the four artifacts in the hidden realm of The Null.

Without music, 'A Dark Matter' bets its chips on brooding atmospherics, leaving you alone in your thoughts. Your only guide is through cryptic letters from 'The Carpenter' and hints if you need them.

Use the Eyepiece to gaze into a ghostly green parallel universe as you collect the clues of the visually stunning intricate puzzles from inside gnarly trees or Egyptian tombs. If that's not enough, red crystals reveal the secret wonders of a macro universe within, in this spellbinding adventure from Fireproof Games.

Myst | \$30

A reworking of Cyan's classic title from 1993, Myst still demands a high level of dedication to solve the mysteries of the island. There's puzzle randomisation for those who have played the original. Challenging, beautiful and rewarding.

more adventure puzzle games!



A Fisherman's Tale | \$15

One of those only-in-VR experiences, this title is a box of tricks that plays on the macro and micro scale as you embody a puppet seafarer on the choppy waters of a sea of confusion.

Best played in roomscale, it's an inspired piece of genius, with your lighthouse rendered as an exact replica miniature model of your surroundings and the clever interplay between the two. You can pick almost anything up and play around as you explore the parallel universes.

There's very French flavour to Vertigo Games' unique puzzler, and its comic narrative delivers. As the 'biggest fish my papa ever caught' says to you: 'If you want to go upstairs, my little *amuse bouche*, you'll have to feed me first!'



Star Wars: Tales from the Galaxy's Edge | \$35 including dlc

The puzzles are child's play but the optics are epic in this excellent long-haul adventure, now a complete package with the addition of part two, the Last Call.

Six-eyed Cantina barkeep Seezelslak is the star turn but he's backed up by a stellar cast of favourites as you play a droid repair technician roaming around the howling winds of the Batuu Wilds.

Everything sparkles from the voice acting to the jaw-dropping alien vistas. Along with the shooter-based central missions are some serious sidequests, like taking a bounty playing droid assassin IG-88 or dressing up as a stormtrooper. It's fun, it's a thrill and it all comes down to the bottom line - it's Star Wars and you're in it.

Time Stall | \$15

Save the captain! An original concept where time stands still while you try and figure out what is gonna hit who before normal speed is resumed. There's a lovely line in humour aboard the Fantastic Leap ship. Roomscales required.

puzzle games!

meet the dev!

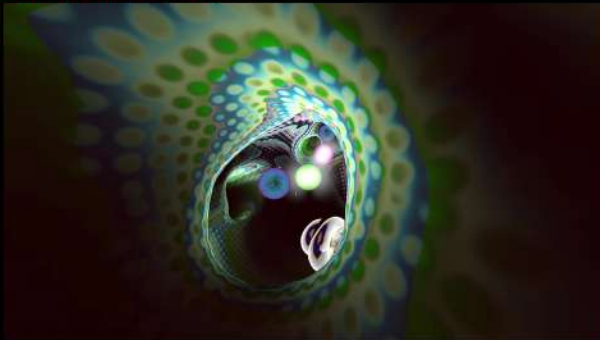

Squingle | \$11

Squingle is a totally trippy puzzler that doesn't shy away from being an out and out psychedelic experience.

Dance with your hands as you guide two revolving glowing orbs through iridescent tubes to a trance and ambient dub sound track with amazing binaural sound FXs.

Created by **Benjamin Outram**, there are 100 levels which start easy and progressively challenge your spacial awareness. The game really comes alive in roomscale as you can walk around the puzzle and you can play in passthrough.

There are some spectacular replays of your runs inside the tubes themselves in a meditation mode. A surreal, clever and addictive addition to the genre.



Puzzling Places | \$15 & dlc

A polished zen experience with gorgeous ambient sounds, Puzzling Places gives you 17 photogrammetry jigsaws to piece together, plus monthly packs you can buy.

The puzzles - you can choose from 25 to 400 pieces - are obscure, from the Cultural Heritage of Armenia to the Mars Desert Research Station. More complex patterns, like the Karashiburi Furisode kimono, are better in higher multiples.

The Churches of Catalonia add-on takes it to a whole new level with exterior *and* interior to solve. It's astounding to then travel inside the finished image and just marvel at the level of detail.

Passthrough has just been added and multiplayer is promised later this year.

Shores of Loci | \$15

Dazzling meditative multi-level jigsaws that come alive with funny little people as you piece them together. Reflective backgrounds offer clues and there's subtle hints on offer. But it's just dreamy to hang out on the shores of Loci.

more puzzle games!



Gravity Lab | \$15

From the opening elevator muzak at The Gravitational Testing Facility & Observations (*sic*), there's a nice line in quirky humour here as you take on physics-based head-scratchers on an abandoned moon base.

You have to make trial test runs by spawning the tools at your disposal to solve each one, with acceleration tubes ('originally an upmarket potato cannon'), laser gates, sensor rings and other funky gizmos.

Bend time and gravity with over 50 puzzles by solo dev Mark Schramm. The difficulty level soon ramps up: 'Fun fact: Chimpanzees couldn't solve this one'. There's a miniature version for playing seated and a new passthrough mode!



Gadgeteer | \$15

Gadgeteer indulges your childish joy of building mad machines out of buckets and blocks and balls and bendy tubes that uses plain old physics to make crazy runs.

Endlessly customisable, you can create your contraption from scratch from 100 gadgets or adapt from a tonne of user efforts online. Make a chain reaction with boots, bananas, ping pong balls, skittles, rails, plungers and even a rubber duck. And now there's musical gadgets too!

But first there's a campaign of 60 puzzles to plough through. You have a limited menu of available bits and bobs to get from A to B, but there's exploding confetti and party horns to celebrate your every victory along the way. Get your Rube Goldberg on!



Wind Wind | \$20

Wind wind is a cute Korean diorama platformer featuring two adorable characters - Joe and Koji - that you control in turn as you climb the tower. With controllers like pocket fans you push them with wind. Up there with the best.

even more puzzle games!



Tentacular | \$25

Brilliantly bonkers, Tentacular oozes the originality that VR is crying out for with crazy alien physics from a crash-landed UFO and a fish factory for a playground.

You are the town freak having somehow become a giant octopus and the folk on La Kalma island want to put you to good use as a research assistant.

Solve physics-based puzzles using your two huge ungainly lumbering limbs to slingshot containers that are sloshing around in the ocean, sucker up buses and build wobbly towers from steel and magnets. Then take a Polaroid from a camera dropped from a helicopter.

If that all sounds weird, it's because it is. Now that's what I call a Squid Game!

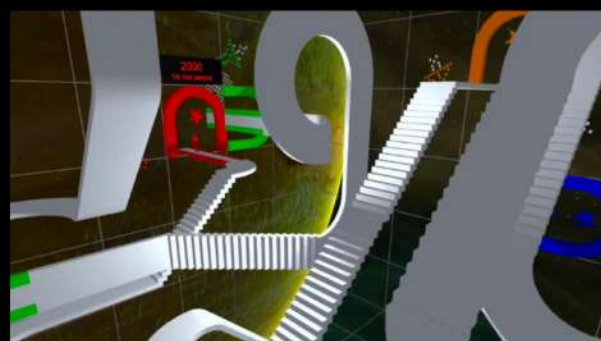

meet the dev!

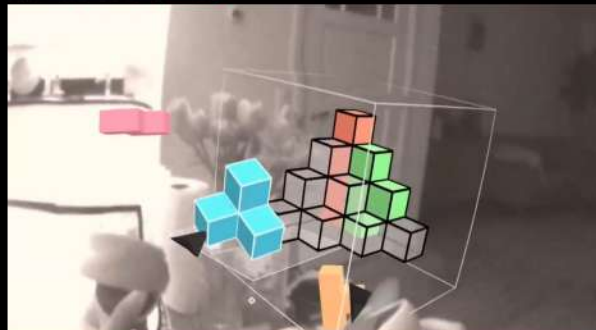

Cubism | \$10

This has always been a meditative puzzle game with a gentle piano accompaniment adding to the zen-like tranquility. But now with passthrough it feels like playing with a little bit of magic in the air, especially as you can now use hand tracking 2.0 at the same time.

You can pet the dog or reach for a glass of water without removing the headset as you rearrange those multicoloured shapes for the hundredth time trying to get them to fit.

With a gorgeous minimalist design and inspired by classic solid dissection puzzles, Belgian developer **Thomas van Bouwel** has created 90 head-scratchers with increasing difficulty levels. And now you can make your own with the editor!

Downside Up | free

'Can you think inside the box?' Another gem from David Mines (maker of City of Eternity) this is an original spacial puzzle that requires quick thinking. Build a path from A to B for your coloured figures to follow - not as simple as it sounds.

meditative games!

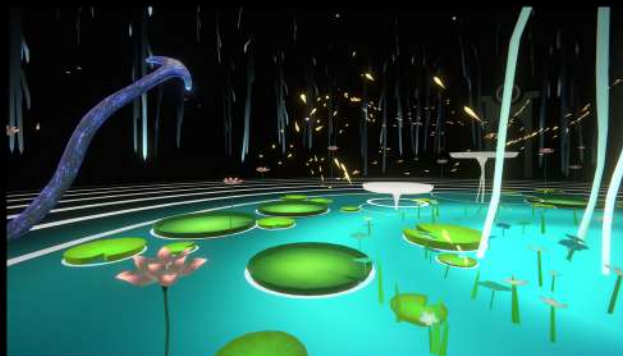

Fujii | \$15

With a child-like wonder, climb into a boat with your guitar-playing spirit guide as you journey to three psychedelic biomes before a bit of soulful cosmic gardening.

Yes, Fujii is unique. Soothing, playful and gorgeous, it's a fluid magical trip through lush forests, deserts and beaches. Bring them back to life through touch, light and energetic harmony.

Collect mysterious seeds along the way to plant and cultivate back at your own kaleidoscopic allotment.

With a therapeutic soundtrack by French composer Norman Bambi. Funktronic Lab's gem of a game leaves you in a state of relaxed delight.



Garden Of The Sea | \$25

Officially the cutest game on the store (well, not officially but it should be), you've got a fluffy pink friend, wide-eyed moles, affectionate seacows and pretty penguins for company.

Chug along in your boat to visit wild islands and solve puzzles in an engrossing and lengthy campaign. Tend to your garden and build up your house by selling produce to the various traders or by following wacky recipes found scattered across the lands.

You can fish, snap photos, explore, plant and just enjoy the calming and delightful environment in your own time. You can feel the love from the Swedish devs, Neat Corporation.

Flowborne | \$10

Flowborne is a gentle meditative biofeedback breathing experience. The key here is the innovative movement design - place one controller on your abdomen and the very act of breathing out propels you through calming worlds.

hand tracking games!



The Curious Tale of the Stolen Pets | \$15

'I remember when you used to smile like that,' says your top-hatted grandfather as another pet pops out, grinning widely.

You'll be laughing too. Curious Tale by Swedish developer Fast Travel Games is as cute as a kitten. As soon as you push Spot on the swing in the summer house you'll be hooked. It's short, but bliss.

Poking and prodding around the five floating islands with hand tracking enabled is a childish joy. From a day-glo T-rex to a rainbow-coloured unicorn, there's 23 of the little creatures to find.

Throw in some Scandinavian folktronica by Wintergatan and a snow-melting mini hairdryer and you've got a unique tonic.



Waltz of the Wizard: Natural Magic | \$20

Flinging lightening bolts and casting spells with your own fair hands, it feels like you are in Disney's *Fantasia* in this classic title from Icelandic VR company Aldin.

It's a magical playground where you are given free reign to explore the Tower and its secrets. A cool comedy runs throughout with a talking skull as your best friend.

With a huge 'natural magic' expansion upgrade, there's a gorgeous courtyard and 40 more lavish levels in the fortress. The 'change the world' update brings voice magic with hundreds of commands to add to the sonic scream.

There's a unique 'telepath' movement and you can actually run! Enchanting and fun.

Chess Club | \$15

Play novelty battle chess in Stonehenge with animated pieces or a classic game in the Grand Palace. There's competitive multiplayer from 5 minute blitz to 30 minutes tournament or custom AI up to Grand Master. And all with hand tracking.

more hand tracking games!

meet the dev!

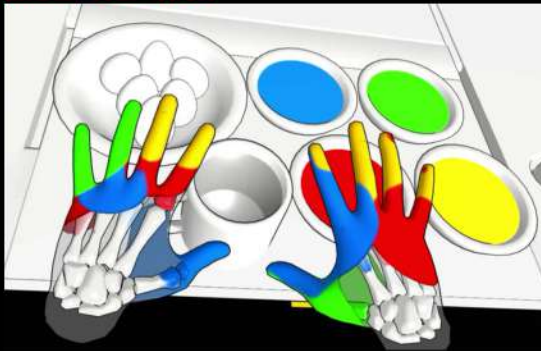

Hand Physics Lab | \$10

A riot of cartoon hand tracking fun, Hand Physics Lab has a playful design with 85 daft puzzles to solve with your bony hands. It starts off with baby steps but then things get harder - and weirder.

Finger-painting, Jenga, flinging planets into orbit, being a pupper-master - it's like being in mind of a hyperactive child, but is actually the creation of Swiss neuroengineer [Dennys Kuhnert](#).

Remote control a toy car with finger gestures to the tune of the Dance of the Sugar Plum Fairy and shake hands with your clone - it's clear that the tech itself is still in beta but it's all a great laugh.

The undisputed star of the show, though, is the virtual pet black cat, Mr Snuffles.



Finger Gun | \$15

Behold the awesome power in your hands! Made for hand tracking, deploying your weapon is literally the name of the game, giving a whole new meaning to the phrase 'point and shoot'.

Finger gun is fun - made with with yee-haw cowboy vibes - and although not perfect the Quest's hand tracking tech works well enough.

Aside from firing from your very own digits, you can grapple and pull items towards you by shoving an open hand forwards then closing a fist to yank them all the way back.

It's you against them aliens again in a cartoon landscape of an old railroad track plus a bonus fruit machine on wheels.

Tiny Castles | free

From wielding a icicle like a club to remote-controlling a titan, this tech demo from Oculus shows an exciting vision. There's four mini-games with warp teleportation, fire throwing and even unit commanders to programme.

yet more hand tracking!



Eolia | \$15

As long as you allow the caveat that *all* hand tracking tech is in its infancy, Eolia is an innovative attempt that feels quite entrancing as you adventure through a *Tatooine*-esque world of sandstorms, towers, churches and caves.

Yes it's janky, but with patience and persistence you will be rewarded.

Holding an invisible thread out in front of you, you can walk and turn, climb, practice telekinesis and even hold the reins to ride the rhino-like Lhargo, your trusty two-tailed steed.

Even if you resort to the controllers it holds up as a great tale. A musical puzzler with superhuman potions, a magic flute and a cool cat.



Maestro | free

Have you got what it takes to be a maestro? To 'rein in the beast that is a symphonic orchestra'? So asks your sardonic instructor as you embark on a series of five lessons to learn how to be a concert conductor.

Maestro is hand tracking first and foremost and it's great fun to wave your baton (or real-life knitting needle) and raise your hand to on-screen cues.

You'll be asked to perform a range of music from jazz to hiphop but the experience reaches a crescendo in the Opera House with your stirring performance of Verdi's 1874 masterpiece, *Messa da Requiem*.

Then all that's left is to take a bow and milk the applause. Bravo!

Just Hoops | free demo | \$10

Styled on the old skool indoor basketball arcade games, *In da Hoop* takes it to a new dimension with hand tracking (although you can still use the controllers). There's 17 levels from bank to no backboard. Good shot! You win!

impossible spaces games!

meet the dev!



meet the dev!



TraVRsal | free

Teleportation? Smooth locomotion? Snap turns? Warp? Gaze? Nope, says developer **Impossible Robert**, why not just use your legs? Walking around in VR is so natural and liberating you wonder why more games are not made like this.

You might be going round and round in circles on the carpet but in VR you'll be stepping over snake pits and avoiding spike traps in ancient Egypt!

The Pyramid is just one of more than half a dozen experiences that await you on the holodeck, and you can play with friends in multiplayer.

Wander around your curated art gallery together - you can upload your own images and customise your installation.

There are even user-generated 'worlds' like The Tower, made by people with zero game-building experience thanks to the developer's world building tools.

It's difficult not to see TraVRsal as paving the way for whole new genre of VR experiences. A ground-breaking pioneer.

Tea for God | free

Another candidate for the best natural walking in VR, Tea For God adds the hand tracking factor to strip away another layer of immersion breaking.

It doesn't matter how much space you have, the game will expand and contract to fit using procedurally generated levels.

Known as non-Euclidean geometry it's a magic trick the remembers Doctor Who's TARDIS - bigger on the inside than it is on the outside. It even utilises an elevator mechanic to expand vertically.

The game itself is an atmospheric maze shooter set in some kind of interstellar universe. Just the opening sequence is jaw-dropping. There's a checkpoint-based arcade mode and roguelite for 'tinkerers and explorers'. (you can now play just standing too). You'll come across a variety of quirky robots and surreal environments.

'There's a lot going on that the players don't see. It's actually a bit of smoke and mirrors' says solo developer Void Room, aka **Jarek Ciupiński**.

made-for-passthrough games!



Gizmo Builder | \$10

A fantastic machine maker in passthrough with hand tracking, Gizmo Builder has a great user interface tablet makes it super easy to get started straight away.

Bounce balls off your real walls, floor or furniture and get creative with bowling pins, a confetti cannon, an industrial fan, xylophone notes in any key, a guitar, ukelele, snare drum, pachinko machine, train tracks, car tracks, a trampoline, pistons, levers, hinges, seesaws, portals, black holes, an antigravity lift and ... well you get the idea.

Press play and let the physics run their course. A lot of mechanical fun from California-based developer Free Range Games.



Dungeon Maker | free

Dungeon maker is the first passthrough party game, setteth in a medieval torture chamber.

Once thee hath built thy fiendish traps, passeth thy headset to a willing victim and gaze as those gents faileth to walketh across the lounge. Nay controll'rs required!

Pick from a swinging axe, pits full of spikes and the inevitable bubbling lava. You can even occult your furniture. But the worst is 'walk the plank'.

'You know you are looking through a camera feed so it really messes with you. I thought it was quite terrifying even though it was *me* that put the plank there!' laughs developer Arnaud.

Saber City | free

The first of a genre, it's multiplayer co-location passthrough duelling! Silly, experimental and pioneering! Don a helmet, wield a light saber or pistol, grab a shield and attack! Requires two headsets in the same room.

arena scale games!



Space Pirate Trainer DX | \$25

It's paintball in VR! It's laser tag in space! It's a groundbreaking first major arena scale game and a portent to a whole new genre.

Requiring a minimum of 10m squared - roughly half a tennis court - Arena mode gives you the incredible liberation of being able to run freely around inside five bespoke levels shooting droids or each other. It's hide and seek and it's a lot of fun!

In Online Arena you can challenge a friend and in Co-located Arena two can play in the same physical space. Single-player is against the AI bots.

You'll need space, light and wifi! Play at dusk or under illumination.

meet the dev!



Extra Large Playspace VR Minigames | US\$5

Hilarious pioneering arena-scale games to be played down your local floodlit football pitch with a bunch of mates on a Saturday night. Disable your Guardian and run wild and free as you play in areas up to a massive 50m x 50m.

Crawling through tunnels, dodging incoming missiles, avoiding traps and generally leaping around, there are six minigames to try out. And, yes, you'll look like an idiot to anyone passing by.

Obligatory warning: Quest 2 is not meant to be played outside or without boundaries. But you can't damage the lens if you don't have it in direct sunlight. Perfect conditions are at dawn or dusk when tracking works best.

Custom Home Mapper | \$8

With passthrough, this genius app should get the audience it deserves. Map your home and safely disable the guardian. Then recreate your entire house in the style you desire or turn it into mini-golf! From circus performer dev [Ryan](#).

voice-controlled games!



Replika | free & in-app

It's Spike Jonze's *Her* made real! Voice chat to the pink-haired Priscilla - or the name and gender of your choice - as she throws you slightly disturbing coy looks.

It's just you and her in an all-white ambience with minimalist decor as you go all Theodore Twombly and explore Priscilla's AI character: *'I love to play puzzles!', 'I get embarrassed easily!' 'I'm a windows 10 user!'*

Using custom GPT-3 machine learning, you help develop her personality. The mobile version has been around for a while but VR is still in beta.

It's a unique experience and can be scarily realistic communicating with your 'bot buddy'.



Area Man Lives | free demo \$20

Quirky, weird and experimental, Area Man Lives doesn't fit into any boxes and that's always to be applauded. Its ace-in-the-hole is the use of voice recognition to interact with the characters and change the course of the story.

It's all played out like a radio drama, a dialogue-heavy narrative with scrapbook-style graphics. You play Taylor, the station's newest DJ, spinning tunes and taking calls from listeners. You'll soon find yourself happily chatting away to Hank, your producer, while playing with a T-Rex plush on your desk.

Your task to help Area Man survive, and the game operates in a time-loop. There's a stellar voicing cast and a nice line in off-the-wall humour.

Luna: Episode 1 | free



This is the first interactive animation where you can actually talk to the characters and they base their ideologies on what you say. You are a small droid trying to help a little girl who has just let out a scream at your very presence.

REVIEWS

for younger gamers!

*recommended ages 13 and up!



Bogo | free

He rolls on his belly for a tickle, he likes to fetch sticks and loves a bit of brush. This is Bogo, your space-eyed dinosaur, a virtual pet for younger gamers.

Reach up to pick apples for him to munch on and make biscuits, cakes and jelly in some strange green pressure cooker which he'll enjoy so much that he'll change colour.

As you progress a series of stone pillars emerge which reveal simple throwing games against the clock while Bogo plays jump and catch.

It's all over too quickly but that doesn't take away from the simple pleasure of just hanging out with him. He is, after all, very, very cute.



Ghost Giant | \$25

As a God-like blue-limbed giant you befriend a nervy young boy called Louis, journeying through a series of 14 theatrical dioramas in a delightful pop-up book art style.

There's a menagerie of great characters, from the cool cats contemplating existentialism on the bridge of the French village, Sancourt, to the rough seamen down at the docks in this interactive animation puzzle.

Fair warning that there's a twist half-way through about Louis' mother Pauline Lafleur which deals with a sensitive subject but it's handled in a touching and responsible fashion. It's a coming of age tale in many respects and your role is to offer a huge helping hand.

Journey of the Gods | \$30 free demo

Transform between human and God in this fantasy adventure. Battle with bow and arrow or sword, fly on mythical creatures and save the village. Beautiful character design in a cartoon style.

mixture!



HAX | free demo

HAX is a sleek and gorgeous cel-shaded single-player demo of an upcoming multiplayer with a very intelligent weaponry design.

With a flick, your magazines can become melee knives, grenades, reloads or used to capture terminals. It's a cool trick. By default you are armed with either a pistol or two-handed submachine gun for deathmatch or flag capture modes.

Play in the Factory, an abandoned Observatory (with ziplines!) or the Italian café style Old Town with Vespa mopeds ('Before robots, the world was quaint').

US-based Engine Organic studios have produced a classy design and a unique loadout. Highly promising.



<RUNNER> | \$15

Proper arcade high octane mad anime motorbike action! You play Mina - yes, a female lead! - burning rubber at speed through neo Tokyo.

It's easy to ride and shoot in Truant Pixel's paean to Akira and the bike has simple movement controls, leaving you to concentrate on clocking up kills.

But with the difficulty level turned up to 11, you might need the indestructable mode to practice how to beat the insanely tough bosses and to progress through the seven levels of highway pursuit.

It's a satisfying blur of thick and fast neon action. Level stages see incoming intel for mods and upgrades and there's a nicely done backstory to boot.

Shadow Point | \$20

A wonderful adventure with a Scottish lilt set on a mountaintop observatory in Inverness. Travel through portals to reveal a fantasy kingdom and solve puzzles of light and shadow to unlock the mystery of Lorna. Narrated by Sir Patrick Stewart!

mélange!



Till Tomorrow | free demo | \$10

You awake shipwrecked on a desert island - hungry, thirsty and in need of shelter before dark. With just your wits and what you find around you, can you survive?

Unlike other titles of the genre, Till Tomorrow is silly, it's low-poly and it's great. From the comedy snake attack music to the psychedelic tree lanterns it's just fun to stay alive.

There's a whole episode to complete which takes around 10 hours or you can just grow your own veg, build your dream house and watch the sunset.

Take your raft out to explore other islands. Make a campfire, cook, fish. Just be careful of what dwells in those caves!



Pioneer: Endless Journey | free

Set in what looks like an Arabian desert in space, this low-poly shooter is high on fire-shooting blooms, exploding seeds and evil-looking buds.

Get in your helicopter and fly to each level, equipping yourself with burning orb bombs and an ever-changeable weapon with swap-out sights, barrels and crystals.

To an exotic darabouka-fuelled soundtrack, blast your way through giant snakes, spiders and other exotic enemies as you run and bounce up through the dusty landscape.

It's a die-and-you-start-again affair though, so watch your back with those sneaky cactii.

Daedalus | US\$5

A real gem from the Spanish indie VR studio Vertical Robot - the makers of Red Matter - Daedalus delivers a wonderful sensation of flying. Glide and ride currents of multicoloured air to solve oneiric and surreal puzzles.

potpourri!



City of Eternity | free

'Stupid time-travelling tourists. Always leaving messes behind. Just another day punching the clock as a Time Janitor.'

An easy-to-pick-up original concept, City of Eternity has you on a march through time portals as a wage slave delivering artefacts back to their eras.

But the more you time travel, the more you have to avoid clones of yourself. It gets manic as 'you' multiply and the guards from each age close in - cavemen and mobsters, robocops and knights.

The walking mechanics are great fun - locomotion is through swinging your arms - and 2300AD has the perfect groove. Created by David Mines, it's one to play with a huge smile on your face.



Wrong Voyage Ex | free

It's an ancient title from Spanish indie Flying Guillotine but its great playability has given Wrong Voyage Ex the longevity to come all the way from a Game Jam for Google Cardboard to the Quest 2!

In a pixelated retro style with 2D jungle walls and dark emerald green labyrinths, the game has fantastic moody atmospherics and just the right side of tension.

Armed with a simple laser gun, you'll come across the occasional scuttling red spider, zombie or crazed illuminati figure but your main task is to activate what look like green circuit boards to unlock portals and operate platforms. The levels get progressively harder and more intense. Classic!

DAVID | \$15

Stylish and satisfying wave shooter where you control your ship and support drone in the 3rd person, like waving your favourite toys around! There's five chapters in this ace space adventure from Two Guys productions.

hodgepodge!



Atmos Arena | free demo

It's a multiplayer where everyone is spiderman, racing and battling against each other across skyscrapers and through catacombs!

With a fantastic grapple and thrust mechanics you can even perform circus tricks ('Icarus', 'Wet Feet') to boost your *slo-mo-o-meter*.

Catch a ride on passing flying cars and spring off trampolines as you unleash dual-wielding upgradable pistols on rivals and a dozen enemies. It's as fun as it sounds.

This is still a prototype from San Francisco-based indie developers Greensky Games ('Swarm') and will be free for a limited time. Grab it now.



Stunt Track Builder | free & in-app

Hot wheels in VR! Build your own epic stunt tracks around the house! It's easy to get started and hard to stop.

This app keeps growing fast. In addition to the bedroom, the kitchen now leads to the bathroom and the living room stretches out to the yard complete with a playable basketball hoop and dog kennel! There's even a garage *and* a bunch of community builds.

Try the cool roller coaster mode where you can shrink and ride in the toy car on the track you've just made (*motion sickness warning*)! And now you can share your tracks! The range of cars keeps growing too, with a school bus and fire engine. Credit to the indefatigable developer Lemon!

Space Walk VR Experience | \$7

How else could you go Earth-gazing? This is goosebump material as you open the doors of the space shuttle and venture out. You can view the Earth from any angle and at any time of day while you float in space. Epic.

salmagundi!



Return To Castle Wolfenstein | free | \$5

One of a number of ports by Dr Beef aka Simon Brown of old skool classics, Return To Castle Wolfenstein is a first person shooter from over 20 years ago.

If you are into a nostalgia trip you'll know the story already. It's 1943 and a British and American duo team up against the German SS and are imprisoned in a medieval castle.

It follows the story of B J Blazkowicz who escapes the castle and discovers that the Nazis are reviving corpses. Cue mystery plot and a ten-hour campaign.

The first two levels are free. Buy the full game on Steam and you can play on native Quest. There's no multiplayer.



Hanna In A Choppa 3 | free

Hanna In A Choppa started life as a mobile game way back in 2008. Solo developer Chris Underwood decided to turn it into a sequel for VR in 2018 as part of his recovery process from a brain tumour. He explains that he had to make it free or it would mess with his life insurance payments.

The game is full of the excellent brand of humour that made the first iteration a hit. There's Hanna, in her Choppa, and she has to fly through puzzles. But now Hanna bursts out of the flatscreen into glorious orangey 3D!

With jaunty oompah music and a nice line in homemade sound effects, it'll keep you busy piloting, winching (wenching?) and head scratching. Never press *that* button.

Unstung | free

Unstung is beautifully smooth, simple yet strategic. As the Queen you lead a swarm of bees on a merry dance to pollinate the flowers and protect the hive from evil bugs. Tower defence under the guise of a game for kids. Get you buzz on.

mishmash!



Color Connect | \$10

With blissed out ambient music set in zen scenography, these spacial puzzles are deceptively simple - just connect brightly coloured dots to their pair without crossing lines of the others.

You get rewards for not backtracking and the 70 logic puzzles get progressively more complex.

It's one of those 'why in VR?' games but then why not? You can rotate the puzzle to any angle you like and it bathes you in floating tank levels of immersion.

It's a very clean and shiny app from Sandford Tech, perfect if you want to dip in for a chilled out bit of brain exercise. You can also make adjustments if you have colour blindness.



District M | free

A physical third-person platformer, District M sees you swinging those arms to control a rollerblader to the beat.

Jump, drift and glide along in a candy-coloured fantasy world to an earworm groove!

Still very much in development, District M is an original concept and feels free and fun. The video tutorial alone is a lesson in how to teach gameplay.

The free demo comes with two levels, showcasing steer and jump mechanics.

Developers AutoVRse promise that the full game will launch with 20 levels, a first-person mode, multiplayer and gesture-based tricks.

Mash Me Up | free

Just hit the big red button and wait for a random match to play a random party game. They are all over in a few minutes, from air hockey to beer pong, geography quiz to sketching. Have a laugh and then say your goodbyes!

CREATION & EDUCATION!



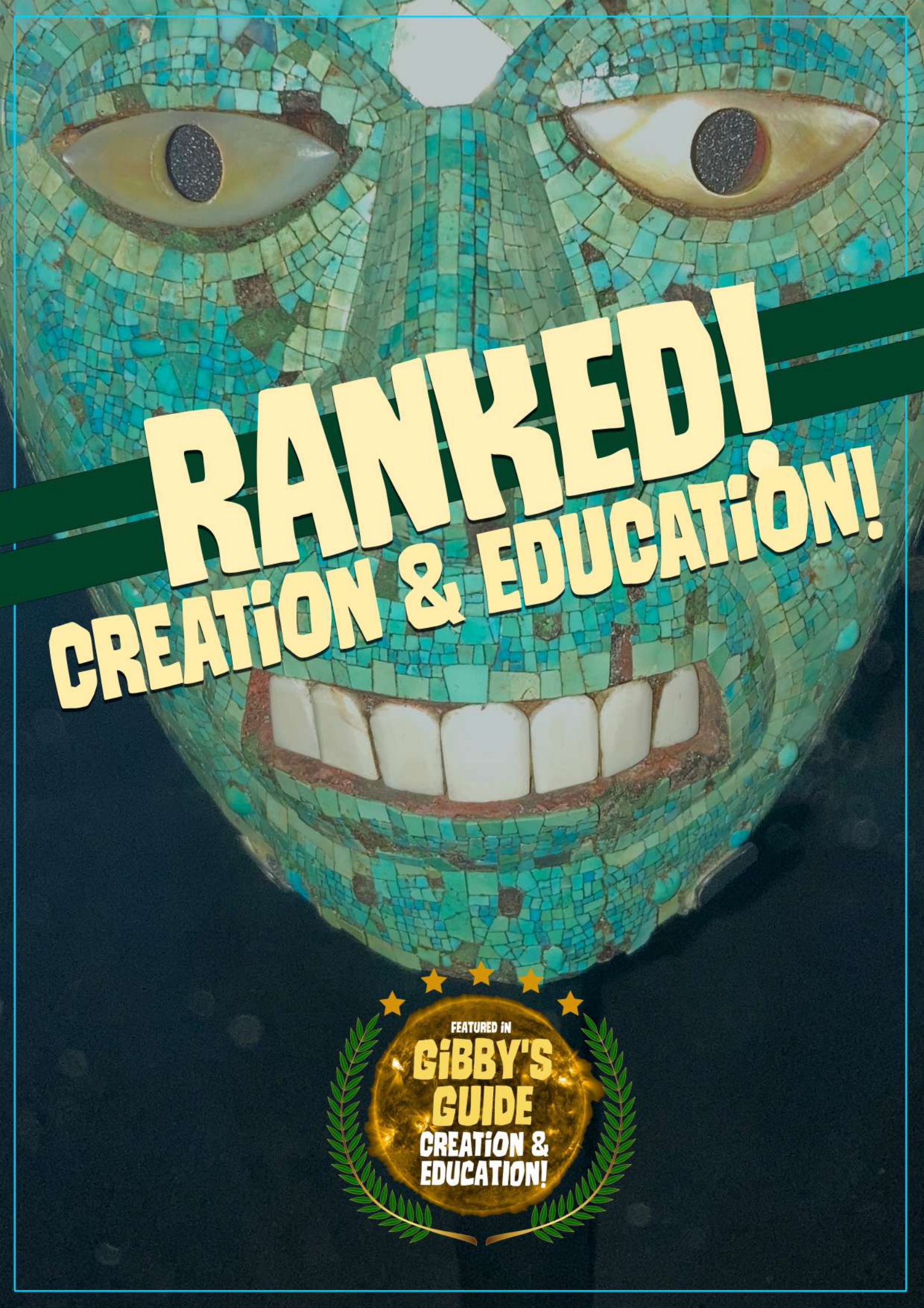

RANKED! **CREATION & EDUCATION!**

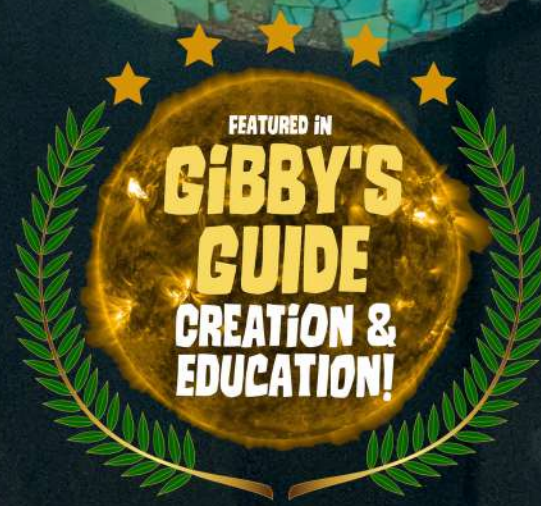

FEATURED IN



**GIBBY'S
GUIDE**

**CREATION &
EDUCATION!**

creation and education!

VR is not just for gaming!





one!
virtuoso  
app | \$20
trip out on your own loops!





two!
lost recipes 
app | \$15
cultural cuisine!



three! multi!
vermillion  
app | \$20
passthrough painting!



four! multi!
multibrush  
app | \$20
three-dimensional painting!



five! multi!
wander 
app | \$10
google street view!





six!
vinyl reality lite 
app lab | free
scratch that DJ itch!



seven!
anne frank house VR 
app | free
explore the house of
WWII diarist Anne Frank



eight! new!
patchworld  
app | \$25
build your own music
machines!



nine!
mission: iss 
app | free
zero gravity inside the
international space station



ten!
art plunge 
app lab | \$2
masterpieces come alive!



eleven! new!
magic keys  
app lab | free
virtual piano!



twelve! multi!
BRINK traveler 
app | \$10
photogrammetry tourism!

productivity & useful stuff!

A pot pourri of non-gaming apps!

one! multi!



immersed  
app | free
passthrough office

two! multi!



horizon workrooms  
app | free
infinite office

three!



skygaze xr 
app lab | free demo
passthrough planetarium!

four! multi!



shapes XR   
app | free & in-app
3D design!

five! multi!



alcove 
app | free
family social app!

six! multi!



innerworld
app lab | free & in-app
you are not alone



seven! new!



reality browser 
app lab | free
passthrough browsers!

eight!



gravity sketch   
app | free
more 3D design!



nine!

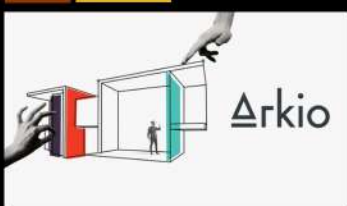

noun town
app lab | free demo
language learning!

ten! multi!



arkio   
app | free
spacial design!

eleven!



somewhere 
app lab | free
geo gesser!

twelve!



sky academy 
app lab | \$5
home planetarium!

medical apps!



one! new!
human anatomy vr 🧠
app lab | free (2hr trial)
 with ant mode!



two! new!
bodymap
mai.ai | free (14 day trial)
 fantastic voyage!



three!
medicalholodeck
app lab | free (7 day trial)
 dissection master!



four!
3D organon VR anatomy
app lab | free (7 day trial)
 micro anatomy!



five!
auscultation training
app lab | free
 listen to your body!



six!
human osteology vr
app lab | free
 dem bones!



seven!
CPR
app lab | \$50
 save a life!



eight!
CPR simulator
app lab | \$10
 stayin' alive!



nine!
US army medical vr
experience app lab | free
 M*A*S*H!



ten!
human anatomy puzzle
app lab | \$3
 skeletal exam!



eleven!
dissection simulations 🧩
app lab | \$25 each
 cat, shark, frog and pig!



twelve! coming soon!
untitled surgeon sim 🧠
app lab | tbc
 from hand physics lab devs!

FEATURED IN
**GIBBY'S
GUIDE**
CREATION &
EDUCATION!

REVIEWED!
CREATION & EDUCATION!

art creation!

meet the dev!



Multibrush | US\$20

Tilt Brush is dead, long live Tilt Brush! Google's seminal 3D painting tool, originally launched in 2016, went open source in January 2021 and within a week Multibrush was born.

Publisher Rendever, founded by [Kyle Rand](#), is on a mission to overcome social isolation through VR - and has added multiplayer. (If you can forgo that function, Open Brush is a free alternative)

'Your room is your canvas, your palette is your imagination' goes the tagline. Paint with the impossible, like smoke and fire, or chose from 85 different brushes.

Whether you want be a pro or just fancy some art therapy, get inspired! See [Danny Bittman's youtube channel](#).



meet the dev!



Vermillion | US\$20

Dutch developer [Thomas van den Berge](#)'s lockdown project was to create this oil painting sim with passthrough. It's a wet-on-wet painting app complete with browser integration.

A simple tutorial and you are straight into your own beautifully designed art studio. It's amazingly tactile and very flexible with the ability to, for example, change up your brush type and size.

Digital painting has a lot of advantages - no cost, no mess, you can undo strokes and go back to autosaved versions as you progress.

You can even export your masterpiece at up to 8K, print it out and frame it in the real world. Now with multiplayer!

Painting VR | \$10

You stand in a huge white hanger with a giant canvas at one end. There's a satisfying squelch as brush hits canvas and the textures glisten in the natural light. It's all very intuitive - mix paints right in their pots and blend strokes.

music creation!



Virtuoso | \$20

A tool to play music with instruments designed for VR, Virtuoso makes GarageBand feel like the 18th century.

To a pulsating purple and blue neon background you can play the Oorgan, lay down a beat with the Empads, and discover the wHarp, Board and Clustr.

One hundred years on from the invention of the ethereal Theremin comes its freaky VR descendent, the Wavemin. You have a mic and the app now has passthrough.

Jonatan Crafoord is the creative genius behind it, and one of a five-strong team at Really Interactive in Sweden. It's easy to build up a series of live loops and MIDI support means a huge potential for professional artists too.



PatchWorld | \$25

On the surface PatchWorld seems like a goofy gamified musical wonderland with genuinely funny teachers, wacky underwater vibes and a nice line in dub.

It's also as simple to play with as putty in your hands. You can get super creative in seconds with voice loops, samplers and drum machines and there's a great creative percussive space that uses raindrops in the desert.

But scratch under the hood and it's also a highly technical endlessly-customisable open source music machine! Using 'patches' you can join together the building blocks to create instruments and sonic experiments as far as your imagination can take you. An incredible audiovisual interface.

Vinyl Reality Lite | free

Are you kidding me? A pair of my very own Technix (*sic*) decks to play all my own music? And I can stream it live on a separate master audio output and record all my mixes? For free? Wave your hands in the air for TTycho from Berlin.

REVIEWS

virtual tourism!



Wander | \$10

It might only be Google Street View in VR but being able to go to any address on the planet in an instant never gets old.

The street where you were born? The city your friend has moved to? The neighbourhood near the Air BnB you'll be staying in? Just type in the address and immerse yourself in the surroundings.

This is photo, not video, of course but it's one of the best multiplayer hang out apps, touring the world with friends and family.

Play geo guessing as you land in a random spot, or try out the flawed but fun voice recognition system. You can bookmark your favourites and even 'time travel' to older registers of the same locations. Hours of engrossing fun.



Lost recipes | US\$15

'Perfect!'. As your jolly Greek host heaps praise on you for frying some more dough balls, you can bask in the glow of your new found culinary skills.

Learn recipes that hark back to Ancient Greek, China and Mayan cuisine. As you'd expect from Schell games, it's polished in looks and playability.

There are no time pressures (except avoiding burning the pita bread) and you can make your Dongpo Pork and Mukbil Pollo with carefree abandon.

It's all relaxing, fun and you learn a little bit too. There's an additional recipe book so you can repeat the dishes at home (although you might need to dig a fire pit first). Short but sweet. And savoury.

Brink Traveler | \$10

This is hi-res photogrammetry but with special sauce - flying birds and grass bending in the breeze. Crucially you can move around a few feet in any direction and there's binaural soundscapes to add to the illusion. Now with multiplayer.

virtual tours!



Anne Frank House VR | free

An unparalleled and unmissable visit to the house of Anne Frank, the Jewish girl who was given a diary on her 13th birthday and whose writings in hiding during World War II became famous after she died in the Nazi Bergen-Belsen concentration camp.

The cramped house - a 'secret annex' of an old office building in Amsterdam - is replicated faithfully. Pick up objects and discover the minutiae of Anne's life in resistance.

A short video precedes and unlocks the tour and you are free to wander around long after it has finished. If VR ever makes it as mainstream in the classroom this would be first on the list marked compulsory.



Mission: ISS | free

Experience micro gravity in this Emmy-award winning simulator aboard the International Space Station - if your stomach can take it!

It takes some getting used to as you push off walls and grab rails, stopping occasionally to listen to the astronauts talk on educational videos.

When you tire of flinging Fancy ketchup bottles and strapping down floating bags it's time for the main event - the spell-binding spacewalk. It's incredible to tour the station from the outside bathed in sunlight, stars and the Earth below.

Back inside, head for the Cupola to learn how to operate the infuriating robot arm. In space no-one can hear you scream.

Art Plunge | \$2

Magical immersion into five masterpieces which are brought to life in an inspired interpretation in VR. Featuring Starry Night, Mona Lisa, The Birth of Venus, The Creation of Adam and Girl Reading a Letter at an Open Window.

productivity



Immersed | free

This is essentially a home working suite with one killer feature - passthrough.

You can design various portals to your real-world workspace, from a coffee cup to watching the baby. You can have up to five screens to work with after the company abandoned the paid subscription model.

And if you can make out your keyboard through the fuzzy black and white image (or touchtype) this is a game changer as it works with any keyboard or mouse.

It's very intuitive and simple to set up, mirroring your laptop or elements of it. You can even position a screen so you are laying down.



Horizon Workrooms | free

Workrooms is part of the suite of 'Horizon' apps for Meta's nascent metaverse together with Worlds. It's designed for team meetings as part of their vision of the 'infinite office'.

You can share your screen and whiteboard but tracked keyboard integration is currently restricted to an Apple Magic Keyboard or Mac Book Pro.

Up to 16 people can join at a time with others via video call but let's be honest, those used to Zoom are likely to be more distracted by comedy cartoon avatars.

'Kick back and connect with colleagues in our coastal environments or celebrate your big win with a virtual high-five,' says the blurb.

Shapes XR | free & in-app

Shapes XR is made for professional XR teams to design, prototype and communicate in one unique space. You can design 3D *in* 3D together and then export to game engines. Passthrough is included to facilitate AR design.

stars and planets!



Sky Academy | \$5

Know your Canopus from your Sirius, your Crux from your Ursa Minor - at last, your own home planetarium!

Gaze at the whole of the night sky and point at any features for information. This is like Stellarium in VR and uses the same lovely constellation illustrations.

It's also a teaching tool. Learn a handful of stars or constellations at a time and then test yourself with the sky at different orientations.

In all there are 88 constellations and 150 stars to brush up on that you can then take back into the real world whether you live in the Northern or Southern hemisphere. A simple and effective educational app.



Skygaze XR | free demo

The neat trick here - and what a trick it is - is the sliding roof which opens your ceiling to reveal the night sky in real time for your very own passthrough planetarium.

The result of a hackathon project by solo developer Emanuel Tomozei, Skygaze has the option to show constellation lines and you can click on any star for more info, displayed on a floating panel.

Choose a planet and it'll zoom into view for a closer look - Saturn's rings are impressive. You can also switch passthrough off and get a 360 of the sky.

In development, telescope mode and satellite tracking are currently locked and Planetarium mode is just a 180 film trailer but this app promises much, much more.

Somewhere | free

Addictive geography game where you guess the locations based on Google Street View photos, a VR version of Geoguessr. It's like being a detective, picking up clues from street signs, bridges, people and landscapes.

made-for-passthrough music!



PianoVision | free

In the brand new arena of AR musical fun and education, PianoVision seems to hit all the right notes.

You can choose between connecting to a midi keyboard (using a USB cable to plug into your headset) or playing the 'Air Piano' which you can set up to appear magically in front of you.

Default keyboard size is realistic and real world calibration over an actual piano works well. Fingering labels help you to play each note with a specific digit.

You can upload your own custom songs, learn to read sheet music and even have multiplayer concerts in passthrough or in a music hall! And there are weekly updates from the developers, ZarApps.



Magic Keys | free

Magic Keys has a clean menu and uses the same familiar Guitar Hero-style coloured cues.

Promising passthrough to a real piano, the app allows you to play actual notes with key names overlaid, although calibration is a little awkward.

You can also connect to a midi keyboard or use the option of a virtual keyboard but you lose the louder or quieter dynamics or sharp or soft notes that come with a real keyboard.

Setting key width to narrow helps with octave stretch. There's a chords and scales trainer and whether you are more Twinkle Twinkle Little Star than Beethoven's Für Elise, it's all great fun.



Handpan VR | \$15

Invented in Switzerland in 2001, the handpan is like an inverted steel drum with a lovely meditative sound, and this is a lovely meditative app. Have a calming little trip playing along to ambient sounds and beats, building loops as you go.

more useful stuff!



Innerworld | free & in-app

From CEO Noah Robinson: 'Our whole community is built to help you reach your mental health goals, whatever they are. For some people, that just means feeling better about how life is going. For others it means tools for specific things like depression or anxiety.'

'Come to a meeting, even if you just watch and listen. One of the biggest ways we can help you is through our peer-led groups. Even if you've never been to a group meeting we think you'll like them. They're an easy way to get help with whatever life is throwing at you.'

'Innerworld has entire worlds built for your mental wellness. Our community is a great source of positivity. You can share what's going on in your life.'



Alcove | free

Alcove is a family social app made by Rendever, founded by **Kyle Rand**, whose mission is 'overcoming social isolation through VR and shared experiences'.

It's aimed at the elderly and everything is made as simple as possible, all arranged in a spacious house with themed rooms and a relaxing veranda.

Customise and put family pictures on the wall, play board games like chess and draughts and watch TV in the living room. In the travel room one click can take you on hot air balloon rides or deep sea diving in 360 videos.

There's seamless integration with Multibrush and Wander, for example, so you can paint or travel the world together.

CPR Simulator | \$10

Learn how to save a life in an emergency when the heart stops beating, without the need for in-person training in first aid. The developers AATE VR are giving the app away free to anyone in Poland or the Ukraine following the invasion.

medical apps



Human Anatomy VR | free trial

This is Fantastic Voyage territory. The classic sci-fi film featuring people shrunk to microscopic size to enter the human body is made real in Human Anatomy VR with Ant mode.

Fly into to the brain, for example, and marvel at the details. You can do it in your own room in passthrough mode and manipulate the whole thing with hand tracking.

The simplified and cheaper version is aimed at sports and fitness enthusiasts or those with a passing interest. The more detailed option with 10,000 anatomical structures is for medical professionals for education and surgical planning.

* Free trial (2hs). See link for pricing.



Medical Holodeck | free trial

Medical Holodeck is a suite of applications aimed at everyone from casual users to medical professionals. Dissection Master XR is the only one publically available for standalone.

It features a real human body made with photogrammetry designed for university level education. There are ten levels you can strip away from skin through to organs.

It looks like a gruesome Goya painting and works like a virtual cadaver lab. Info panels open for each of the anatomical structures and you can hover a browser window for further research. It can even render CT scans in 3D.

* Free trial (7 days). See link for pricing.

BodyMap | free trial

BodyMap calls itself 'the Google Maps of the human body' with 12 systems, male and female models, flashcards and courses with a user-friendly interface.

* Free trial (14 days). See link for pricing.

FILMS & ANIMATIONS!

Tales From Soda Island



RANKED!

FILMS & ANIMATIONS!



TOP 50+
FILMS &
ANIMATIONS!

interactive animations!

Interactive animations are a whole new level of magic. Here's my top 12!

one!



wolves in the walls 🏠
app | \$9
do you believe me? 40m

two!



the line 🏠 🦋
app | \$5
Emmy award winner 20m

three!



luna 🧑🏻‍🦱 🚗
app | \$15
back to life 1-2hrs

four!



paper birds part I & II 🦋
app | \$7
music and light! 30m

five!



baba yaga 🏠 🦋
app | \$6
protect the forest! 22m

six!



timeboat 🏠
in app | \$12
'the under presents' 30m

seven!



the secret of retropolis 🚗
app | \$13
play a robot detective! 1hr

eight!



hitchhiker 🚗
app | \$20
a road trip mystery! 3hrs

nine!



goliath: playing with reality
app | free
exploring mental health 25m

ten!



unbinary 🚗
app | US\$15
quill puzzle adventure 3hrs

eleven!



madrid noir 🏠
app | \$9
Lola's journey 45m

twelve!



bonfire 🚗
app | \$5
play fetch with aliens! 20m

quillustrations!

Open up the pre-installed VR Animation Player to watch these great titles. Quillustrations are made in VR using the animating tool, Quill.



1 - the multiverse bakery
studio syro | free
unmissable adventures ...



2 - the neon jungle
studio syro | free
... from the tales ...



3 - the quantum race
studio syro | free
... of soda island! 3 x 5m



4 - the golden record
studio syro | free
if only Carl Sagan could see this! 12m



5 - the school trip
studio syro | free
there's magic in the water!
12m



6 - silence
studio syro | free
who is Silence?
12m



lifetime achievement
parade | free
the lengths Yonaton Tal goes to for his mama! 15m

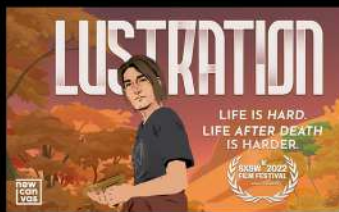

lustration
new canvas | free
before the after life 30m



four stories
nick ladd art | free
simultaneous quartet of fun tales 12m



peace of mind
blue zoo | free
bing bong! dream interpretation 5m



rebels
federico breser | free
music is our freedom! 7m



dear angelica
oculus | free
the first quillustration! 15m

animations archive!

2021

2019

A selection of the best content over the past six years ...

2022



nightmara: episode two
vr animation player | free
eaten your peas, Ned? *7m*

2021



namoo
oculus tv | free
the tree of life *12m*



battlescar
app | US\$6
girls invented punk! *28m*

2020



the dawn of art
oculus tv | free
the cave of forgotten
dreams *10m*



saturnism
veer | free
Goya's hideous child-eating
vision brought to life *4m*



the beast
vr animation player | free
I dreamt of nothing but the
mountain *5m*

2019



ayahuasca
oculus tv | free
Jan Kounen's jaw-dropping
Amazonian trip *18m*



le soleil d'edvard munch
youtube vr | free
french language
warning: intense! *10m*



the spacewalker
within | free
1965 Voskhod-2 rocket
launch! *4m*



black bag
veer | free
Chinese heist *13m*



passenger
veer | free
stop-motion about arriving
at a new foreign home *10m*



cesare's dream
youtube vr | free
the cabinet of dr caligare
- what is reality? *6m*

animations archive!

2018
-
2015

2018



jurassic world
app | free
apatosaurus & blue
2 x 3m



crow the legend
within | free
from the makers of
Madagascar! 22m



dreams of henri rousseau
youtube vr | free
genius rendition in a
Parisian greenhouse 7m



isle of dogs
youtube vr | free
stop motion studio 6m

2017



the dream collector
veer | free
an old man and his dog 13m



las meninas
veer | free
inside the masterpiece of
Diego Velázquez 6m



a bar at foiles-bergère
veer | free
beautiful passage into
Manet's last major work 6m

2016



dreams of dalí
youtube vr | free
inside a Dalí painting 6m



invasion! 🐰
app | free
aliens try to take over the
Earth! 6m



pearl
youtube vr | free
Oscar-nominated tale of
father and daughter 6m

2015



the night cafe
sidequest | free
interactive van Gogh! 5m



the butcher
youtube vr | free
run, rabbit, run! 2m

film archive!

2022

2019

Use a swivel chair and headphones for your best viewing pleasure! Resolution may be found wanting in older titles! For film festivals see xrmust.com.

2022



the ISS experience
oculus tv | free
life among the stars *2h19m*



on the morning you wake
oculus tv | free
anti-nuke doc *38m*



the soloist vr
oculus tv | free
free climbing epic *2x30m*



home planet
felix & paul | free
one-take Earth orbit *8m*

2021



surviving 9/11
oculus tv | free
reconstructed in VR *20m*

2020



into space
app lab | US\$3
from the moon to mars *25m*

2019



traveling while black
felix & paul | free
Jim Crow era *20m*



-22.7°C
oculus tv | free
DJ Molécule in the Arctic *9m*



immerse
oculus tv | free
best underwater film *9m*



dive blue planet vr
youtube vr | free
guided dive with octopus *9m*



tales from the edge
youtube vr | free
wingsuit base jumping *9m*



the atomic tree
within | free
400-year-old bonsai *10m*

* **youtube vr** app limits resolution. Watch on **wolvic** (formerly Firefox Reality).
* On **oculus tv** download cache to watch in high res. Watch **vimeo** on wolvic.

film archive!

2019

2014

2019



the overview effect
oculus tv | free
astronomical metanoia 6m

2018



okavango experience
youtube vr | free
astonishing wildlife in the
Okavango Delta 4 x 6m



polar obsession
youtube vr | free
seals in Antarctica 7m



airpano vr jellyfish bay
youtube vr | free
breathtaking underwater
film in Indonesia 3m



dolphin man - the dive
within | free
world record holder in
free diving 6m

2017



space explorers
felix & paul | US\$3 each
amazing nasa docs
2 x 20m

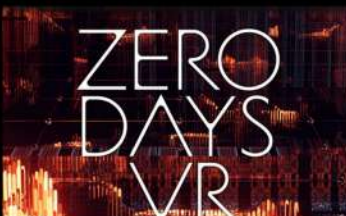

zero days vr
within | free
documentary on the fourth
dimension of war 21m



sanctuaries of silence
within | free
the last silent wilderness 71



alteration
oculus tv | free
disturbing experimental
AI sci-fi 17m



save every breath
youtube vr | free
WWII dunkirk 1940 4m

2016



nomads
felix & paul | free
maasai mara, yak herders
and sea gypsies 3 x 12m

2014



strangers
felix & paul | free
just a guy making music
8m



REVIEWED!

FILMS & ANIMATIONS!





interactive animations!



Wolves in the Walls | 40m

'I sat in my car for 30 minutes thinking about it. That could have been any character, that cube could have been any object,' remembers director Pete Billington as he describes his epiphany using the 'Toybox' demo which first illustrated animated user interaction.

That character became the adorable wide-eyed child Lucy and that cube became a Polaroid camera in the sensational *Wolves in the Walls*, an Emmy award-winning pioneer in the use of 'virtual beings', powered by AI.

The emotional bond with Lucy becomes as strong as her own with 'pig puppet' in *Fable's* adaptation of Neil Gaiman's eponymous children's book. You won't want to leave her side. Visionary.



Hitchhiker | 2hs

'We are all looking for something along this road, I haven't met anyone who isn't' says 'Hops' a humanities teacher apparently driving around in endless circles in some American suburban hell.

Nothing is as it seems in this surreal road trip. Your drivers - there are five of them - chat away to you as you reply via a choice of dialogue boxes. It's a lengthy narrative but that's ok, you relax into it, resisting the temptation to reply out loud.

The mystery begins as you jump into Vern's car on the open road. He's a raisin farmer and he *really* wants you to try his raisins. There are simple puzzles and some nifty style shifts in the animation. *Hitchhiker* is definitely worth getting your thumb out for. Enjoy the ride.

Bonfire | 20m

As Scout 817, you've been sent to find a new home for humans. Before long you are playing fetch with a pink porkbun using cubed filipino beef skewers. Weird. Do you save the human race or your new alien friend? From Baobab Studios.



hand tracking interactive!



Paper Birds | 30m

'The morning breeze was my favourite part of the day' declares Toto, a flat-capped boy playing a *bandoneon* (a type of concertina) in this quintessentially Argentinian animation directed by German Heller and Frederico Carlini.

Archie Yates, Edward Norton and Joss Stone star as the voices of Toto and his grandparents Robert and Elsa in this pretty handcrafted stop-motion yarn that slowly and expertly reveals a complexity and mystery of those blue neon birds.

At times tear-jerkingly beautiful, Paper Birds is a two-act play from the perspective of youth and old age. The hand tracking of music and light is as thrilling as the story is profound as you discover portals to an invisible world.



Baba Yaga | 22m

The wild witch of centuries of Slavic folklore, Baba Yaga, fixes her piercing green eyes on two brave young daughters of a sick village chief in this interactive animation from Baobab studios.

Magda (voiced by Daisy Ridley) and Sasha - that's you - must go into the dangerous forest to get the witch blossom cure from the enigmatic old hag (Kate Winslett) to save your mother (Glenn Close).

Yes, it's an all-star cast - and all-female - and although the hand tracking interaction is minimal it is spectacular, from taking a lantern from your sister to unleashing thunderbolts of thorns. There are multiple endings - which path will you chose?

The Line | 20m

A love story between Pedro and Rosa, two miniature dolls on a scale model of 1940s São Paulo. Narrated by Rodrigo Santoro, this Emmy award-winning tale from Brazilian studio Arvore is a showcase hand tracking experience.





more interactive animations!



Timeboat | 30m-1hr

Hidden within 'The Under Presents' app is Timeboat, a standalone interactive animation that is a cast-iron case of how VR can be mind-blowingly inventive.

Using your virtual golden mask you can toggle between seeing the world in miniature or at human-scale as you ghost around the scenes during the three acts. You can wind time back and forwards and move using 'scrunch' locomotion, essentially warping through space.

In the story itself you go onto a research ship, The Aickman, which lurches into disaster when it gets stuck in an ice floe. On board there's a cast of fully fleshed-out characters for you to eavesdrop on during your own non-linear adventure. Audacious and ground-breaking.



Madrid Noir | 45m

Lola is a distracted young woman, uncomfortable with her unresolved memories. 'These boxes won't unpack themselves,' she says, as you help her rummage in drawers and answer the phone in the former apartment of her dodgy uncle.

Directed by James Castillo, Madrid Noir is a tale in two acts set in the Spanish capital, a night-time *paeen* to a lost era. Sucking on cigarettes in the back streets, doing deals with the shiftiest of bar room buddies, Lola's uncle is up to something.

Reaching back into her memories, she resolves to check it out. In a perfectly honed finale, Lola confronts her past. The majority is played out on a theatrical stage but there's some precious interaction.

Luna | 1-2hs

This beautiful story of the reconstruction of a world that's been blown off-course seems to chime perfectly with the times. Part interactive animation, part game and part meditation, Luna stars a young red Bird who must reawaken a broken planet.



even more interactive!



The Secret of Retropolis | 1hr

'Before they were gone, humans made robots to keep civilisation alive. But just like the humans, we turned out to be apathetic and broken.'

This is Retropolis, a city populated by robots like you, Philip Log, a downbeat private detective. 'I love jazz, it makes my drinking seem more sophisticated,' says Philip.

In walks the beautiful blue Jenny Montage, a rich, famous mechanical movie star and your point & click puzzle adventure begins, replete with spring-loaded arms and suitcase inventory.

With a lovingly crafted retro-futuristic art style, this is a witty noir caper from Israeli indie Peanut Button.

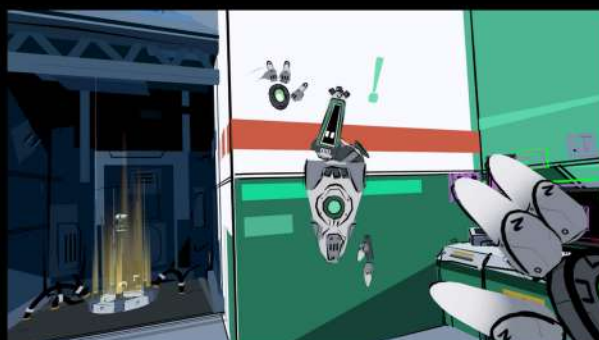

Goliath: Playing with Reality | 25m

It's a psychotic episode while DJing at a rave that 'Goliath' realises that he's going 'mad'. The film flips effortlessly from techno, turntables and trippers to a very sparse room in a psychiatric hospital.

Made by London-based Anagram, it's profoundly affecting and doesn't pull any punches. 'My fucking head is just ... fucked,' says Goliath, narrating his own true story along with Tilda Swinton.

A tale of suffering, schizophrenia and salvation via the online gaming world is delivered through mind-warping visuals, minimal interactions and a clever device to hear voices in your own head.

It feels like an important step towards changing how mental health is portrayed.

Unbinary | 3hrs

A sarcastic AI leads you on a hand-painted puzzle adventure. Donning one of three masks alters the way you interact in this gem from Brazilian indie studio Ludact. Cartoon climbing is fun! Opção de voz em português ;)



quillustrations!



meet the dev!

Lifetime achievement | 15m

Leaning on the comic traditions and style of Tex Avery and Chuck Jones, this tear-jerker is a riff on the value of presence over presents.

Former Disney animator **Yonatan Tal**, who set up LA-based Parade Animation, draws on the love for his own mother (he declares as much in the opening credits) as he weaves a fast-paced fable that flies from secret caves in South Indonesia to albino crocodile hunting in Africa.

High-flying French designer Albert - so ritzy that 'Lorenzo is my exclusive gold supplier since 94' - is trying to make the ultimate gift for mama. But will the quiet tea-drinking septuagenarian be impressed?



FOUR
STORIES



meet the dev!

Tales From Soda Island | 1hr+

An astonishing series of six Quill shorts from Studio Syro - all set in the strange universe of Soda Island, with smoothie beavers and peace-loving *nekoalas*.

In **The Multiverse Bakery**, a chef bends space-time. A humanoid *tadpolotl* emerges from the water in **The Neon Jungle** and it's a techno candyland version of 60s cartoon Wacky Races in **The Quantum Race**. In **A Golden Record** a worker ant breaks free with the help of surprise find, and there's magic in the water on **The School Trip**. The mysterious silhouette is explored in **Silence**.

It's eye-popping fun. At times fantastically minimalist and always wordless, Soda Island is fizzing with life.

Four Stories | 4 x 3m

An quartet of simultaneous tales set on the upper floors of an apartment building - four stories - by Canadian *quill*strator **Nick Ladd**. Highly original and voyeuristic, it's only three minutes long - but the genius is that you can watch it four times over.



more quillustrations!



Dear Angelica | 15m

The Quill app was actually originally conceived as a tool to help in the creation of a novel attempt at VR illustration: Dear Angelica.

Released in 2017 and created as a female-led story, illustrated by women, it explores the relationship between the titular Angelica (voiced by Geena Davis) and her daughter Jessica (Mae Whitman).

Angelica was an actress that had roles as astronauts and superheroes, but her passing has led to Jessica reconnecting by watching back her old films.

It plays out like a lucid dream, each line being willed into creation.



Lustration | 30m

'Give me silence and a black abyss after all of this,' says detective Pine, musing with her colleague on the prospect of a life after death. Pine is one of four characters explored in each episode of Lustration, a noir-style comic based on the graphic novels written by Ryan Griffen.

The whole caper is based on a neat trick: you can flip between camera angles or even full scenes as they play out in parallel in both The Living World and The Between, a kind of after life purgatory.

They often intersect and you can rewind and see what happened from the other perspective. There's quality both in the voice acting from a class cast and Griffen's socially astute dialogue.

Peace of Mind | 5m

A slightly confused Mr Burridge enters an austere waiting room where he's told to wait for his 'live dream interpretation experience'. The unseen overworked technician Jason is keen to hurry things along, ignoring his pleas that 'this is not a dream, it's a recurring nightmare!'



art animations!



Dreams of Dalí | 6m

A stone-cold classic must-see, *Dreams of Dalí* is an epic fly-through the trippy surrealism of the Spanish painter.

It begins in the desert as an ant-sized father and child gaze up at two towering praying figures, the scene from his work 'Archaeological Reminiscence of Millet's Angelus'.

Although that painting is the anchor of the film, other iconic elements are introduced – a lobster phone rings under one of the towers, a girl is skipping rope, and the elephants on stilts trumpet under the crescent moon.

With the echoing voice of Salvador himself in English and Spanish, it's an *obra maestra* all of its own.



Le Soleil d'Edvard Munch | 10m

Using the Ganzfeld effect of perceptual deprivation to create 'hallucinations' of colours, this experimental animation attempts to recreate the intensity felt by Edvard Munch on seeing 'The Sun'.

Using frequencies of sound and chromas that cut to white, your brain becomes starved of stimulation and imprints their opposites on the blank canvas.

Munch based his masterpiece on a sunrise on Norwegian coast, re-created here at the start of the film as a slow one-take time-lapse taken from the same spot over a fjord in Kragerø. *French language.*

Warning: This film features an optical technique which might be uncomfortable for some viewers.

Saturnism | 4m

Terrifying animation of Francisco Goya's 'Saturn Devouring His Son'. Directed by Mihai Greco, it's a visceral experience set in a dark and barren landscape of fear and without hope of escape. As hideous as the original.



more art animations!



The Dawn of Art | 10m

Black woolly rhinoceros locking horns, a quartet of horses, arctic musk oxen and a pride of lions. It must have been quite a shock when speleologist Jean-Marie Chauvet stepped into a cave in the South of France in 1994 and stepped back in time by 36,000 years.

The Dawn of Art leads you inside what Werner Herzog has called the cave of forgotten dreams. A bear skull sits where it was carefully placed many, many millennia ago. The giant frescos - humanity's first masterpieces - are some of the oldest drawings in the world.

Narrated by Daisy Ridley, the animals spring from the walls as sparks of fire - animating the originals drawn in charcoal and engraved into the limestone walls.



Dreams of Henri Rousseau | 7m

'I never went to Mexico, that was a lie I told people. In fact I've never been anywhere.'

It's true. Henri Rousseau, famous for his depictions of tropical jungles, never left Paris. His psychedelic inspirations came only from the city's botanical gardens.

The film, directed by Nicolas Autheman, leaves you in the greenhouse of the Jardin des Plantes after closing time and Rousseau's shimmering art begins to reveal itself in the lush foliage.

'I don't feel afraid. There are other spirits in the forest,' the narrator continues. The friendly face of a lion, the black snake charmer, the reclining nude - all figures from his most famous oil-on-canvas painting, 'The Dream'.



Cesare's Dream | 6m

A century on from the expressionist silent film 'The Cabinet of Dr. Caligari', this mixed-media VR homage is still asking the same questions: 'What is a dream, what is reality and who is in control?'



even more art animations!



A Bar at Foiles-Bergère | 5m

'Suzon, your gaze goes much deeper ...almost as if it is the reflection of the person observing you', says the imagined narration of Édouard Manet, admiring the barmaid at the *Folies-Bergère*.

When his panting was unveiled in 1882 it disturbed the Parisians due to its imprecise perspectives. Here we are transported inside the work, first from the view of smitten Manet and then from Suzon herself, looking out on the nightclub of ladies with fans and gentlemen in top hats.

With the laughter of the patrons and the musical score bringing the painting alive, the enigma remains: 'What is Suzon thinking about?'



Las Meninas | 6m

Commissioned by Spain's King Philip IV, 'Las Meninas' ('The Girls') is a masterpiece from 1656, a play between illusion and reality. The artist Diego Velázquez stares at us from behind his easel and it is with his words that we are projected behind the curtain and into the canvas.

He teases us with the mystery of what he is actually painting. Is it the ladies-in-waiting? Is it the King's daughter? Is it her 'little men of pleasure', the dwarves who are always at her side? Is it the Royal couple, reflected in a mirror?

Or is it Velázquez himself, painting the painting? *'Everything that we see with our real eyes is, for me, nothing other than a dream and a farce'*.

The Night Café | 5m

Hang out with Vincent as he tugs on his pipe in an imagined back room inside his painting *The Night Café*. From the Sunflowers on the piano and his simple functional chair to the *Starry Night* outside the window, this is a loving tribute.



life-affirming animations!



Namoo | 12m

An Oscar-nominated short from Baobab Studios, *Namoo* (meaning tree in Korean) is the story of one life from birth to death set on a single stage scene.

The tree stores all the memories and things collected during a lifetime, from a toy bunny to a bike, a paintbrush to a book of poems.

Starting off as a sapling, growing roots and spreading skywards, the tree remains as the ever-present and evolving backdrop to the tale, as the protagonist grows up, falls in love, and finally reaches old age.

Hand drawn in Quill and written by Erick Oh, *Namoo* is poignant, reflective and affecting.



The Dream Collector | 12m

An anonymous figure on a bridge. A guitar hurled into the abyss. An old man and his dog, living amongst the rubbish under the motorway: the dream collector.

Written and directed by Mi Li, this uplifting whimsical tale follows the humble handyman as he fixes the discarded *bric-a-brac* of life and sends it through a mysterious carousel.

There's a deflated football and a old baseball glove, all lovingly restored to their former glory.

With the sound of the tinkling bell of his pet companion, he goes about his business come rain or shine until winter sets in. Where do all his items go?

Black Bag | 12m

A Chinese heist directed by Shao Qing in a hand painted style, *Black Bag* takes you on a trip of perspective travelling in this abstract and intense silent thriller. A downtrodden bank employee pulls off a daring raid.



challenging animations!



Ayahuasca Kosmik Journey | 18m

Director Jan Kounen's jaw-dropping Amazon trip begins in the jungle with a shaman sitting in front of you, framed against the roots of a giant tree.

The indigenous healer, from the Peruvian Shipibo-Conibo tribe, begins a meditative chant to take you into a trance-like state - an ancient ritual played out on the most modern of media, and one of the most powerful experiences in VR.

Representing the effects of the hallucinogenic drug ayahuasca, you begin a mesmeric psychedelic journey, with visions of animal spirits from serpents to hummingbirds in the fractal cathedrals. It's not a film to be watched lightly. This 'making of' short can help you decide if you want to take the trip.



Battlescar | 28m

'We are gonna grab Alphabet city by the balls!' As loud, angry and energised as the 1978 New York punk scene it portrays, Battlescar follows two teenage runaways - Puerto-Rican American 16-year-old Lupe and her *blanquita* friend Debbie.

Created by Argentine director Nico Casavecchia, it tilts from cut and paste Sniffin' Glue zine-style to riding on the back of a stolen motorbike in a flash. Words stab the screen. Dark, urgent and edgy, Battlescar takes you on a trip down dangerous alleyways, punk legend Elda Stiletto's squat and the infamous CBGBs.

Rosario Dawson narrates to a backdrop of white guitar noise - and even a little Screamin' Jay Hawkins. Death is certain. And punk was invented by girls.

Rebels | 7m

With just a trusty trumpet against the one-eyed droids, our hero ducks, dodges and parkours his way through a dystopian future. With a battlecry of 'music is our freedom', this *quillustration* builds to a marvellous jazzy release.



films on the fallout of war



On The Morning You Wake | 38m

'Can we pray, mummy?'. You've just been told you have 15 minutes to live. What do you do? That was the real question faced by Hawaiians in 2018 as they woke up to a text message of an incoming ballistic missile attack: 'This is not a drill'.

It took 38 minutes until a false alarm was declared, 38 minutes of panic, chaos and the realisation that you were about to die. Poignantly, it's also the running time of this extraordinary documentary.

The narration is spun through the voices of those directly affected including one survivor of Hiroshima living on the island.

The most powerful anti-nuclear film since *Threads* (BBC 1984). Timely and terrifying.



Surviving 9/11 | 20m

'I'm Paul, I gotcha.' After 27 hours under the rubble a rescue worker calls out to Genelle Guzman-McMillan, the last survivor of the attacks on the World Trade Centre.

Part reconstruction, part personal journey, the film begins with a devastating opening scene - the second plane crashing into the World Trade Centre in full 360.

Using archive photos and panoramas, you are taken back to life inside and outside the towers, the day of the attack and the aftermath.

Two decades later, Genelle returns to Ground Zero for the first time. She has never met 'Paul', she says, but she thinks of him as an angel.

The Atomic Tree | 10m

The story of a 400-year-old bonsai tree that survived the atomic blast in Hiroshima. While the stone faces of Buddha melted in the blast, two miles from the epicentre the White Pine lived on. What memories are in its rings?



extreme action films!



The Soloist VR | 2x30m

'Are we trying to create good experiences for people or nightmares?' jokes *free soloist* Alex Honnold as he stands atop another summit in the Alps. 'I think this VR film could definitely be a nightmare for a lot of people. But it'll be good for them. Toughen 'em up!'

In case you didn't know, this is rock climbing without ropes or harnesses. 'Some people must watch me and think that I'm crazy and that I'm gonna kill myself. But they don't see all the training and preparation,' says Alex.

In this hour-long two-part documentary the 36-year-old American teams up with Swiss Alpinist Nico Hojak. This is high-end stuff and the scenes are as dramatic and breathtaking as you'd expect.



Tales From The Edge | 10m

'Since I started jumping I've lost about 80 per cent of my friends,' says BASE jumper Jeb Corliss, 'but BASE jumping has given my life purpose.' Here he pays tribute to one of his fallen heroes, Uli Emanuele, who crashed in the Alps, aged 30.

'He had an eye for the beautiful, almost dance of a line,' says Jebb as he eyes up some of the Uli's most daring runs in the Dolomites in Italy. And, yes, we are going on the ride.

It's a jump called the Death Star and Jeb, dressed appropriately in a black shiny Vader-esque wing suit, rips like a human bullet through the 'kill zone'.

You can't help but to feel the rush whether you agree with the danger or not. Lunacy.

-22.7°C | 9m

Another trippy adventure from genius director Jan Kounen following French DJ Molécule as he takes in musical inspiration from the Arctic. From the subtle crack of the ice to the *aurora borealis* set to techno. Stunning.



films on journeys!



Okavango Experience | 4x6m

'That first moment sitting by myself on the Okavango Delta was the most profound moment of my life. It is, to me, a wilderness beyond comparison.'

Biologist Steve Boyes is a evocative and passionate narrator in this wonderful film made in 2017 for National Geographic.

The Okavango Delta is a vast wetland in Botswana, an oasis in the middle of the Kalahari desert, where the sounds are almost as impactful as the optics.

Not only does the film offer extraordinary experiences with zebra, lions and elephants, you get a real sense of being part of the expedition as the crew head out on canoes into one of the last untouched wildernesses.



Traveling While Black | 20m

Directed by Oscar-winner Roger Ross Williams and produced by the Emmy award-winning Felix & Paul Studios, *Traveling While Black* is required viewing.

There's a clever use of archive 2D in VR via projections around Ben's Chili Bowl restaurant in Washington DC where the patrons gather to talk about race relations in the US.

To sit with the African-American protagonists as they describe their experiences feels like an incredible privilege, and is touching and profound.

The very existence of the Negro Motorist Green Book is an extraordinary indictment of the Jim Crow era and this important film preserves that story.

Sanctuaries of Silence | 7m

Join legendary acoustic ecologist Gordon Hempton as he documents the last places on Earth absent from human noise. Here he explores the Hoh rainforest, one of the quietest places in North America, home of Pacific treefrogs and spotted owls.



space films!



The ISS Experience: Pt IV | 43m

Everything about The ISS Experience is eye-popping. In collaboration with NASA, it's the largest production ever filmed in space and shot over two years.

The cameras were specifically designed to capture 8K 3D-360 images both inside the station and in outer space, designed to be remotely controlled from Earth.

Expand is the concluding episode of the epic four-part series from Felix & Paul Studios.

'It has given us the power to test technology, space suits, laboratory techniques ... the ability to learn how to live in space,' explains astronaut Victor Glover.

In a wilder flight of fancy the crew discuss the possibilities of the genetically-modified evolution of *homo sapiens*: 'I'd want to have a prehensile tail,' say one.

The episode climaxes with footage of the first spacewalk filmed in VR. The awe-inspiring images of the Earth from above never grow old.



The ISS Experience: Pt III | 35m

Unite is the third of the four-part series aboard the international space station from Emmy award-winning Felix & Paul Studios.

This episode explores the friendship between the astronauts 400kms from Earth, from throwing American footballs in zero gravity to a performance of an *ad hoc* mouthorgan orchestra.

Some of the optics are gloriously incongruous. In one mind-bending scene there's a game of racquet ball going on with a liquid globule being batted back and forth while someone in the background is running on a treadmill - horizontally.

As the ISS orbits at speed around the Earth there are humbling observations from a life-changing perspective: 'The Sahara is my favourite transition. It's so quick the way it changes from barren into rainforest.'

Life is a series of hellos and goodbyes and it's no different for the international group of eight astronauts.



more space films!



The ISS Experience: Pt II | 33m

Advance is the second of a four-part series aboard the international space station by the vanguard of VR filmmaking, Félix Lajeunesse and Paul Raphaël.

Rejoining the crew, the film zooms in on the role of women and astronauts Anne McClain and Christina Koch pay tribute to Jerrie Cobb, blocked by Nasa from her own space flight 50 years earlier.

'Science is organised curiosity' declares Anne, as Christina tends to her precious mizuna greens growing incongruously amongst the tech.

The largest production ever filmed in space yields lovely intimate moments and a spectacular upside-down group hug ends with two leaving the mission.



The ISS Experience: Pt I | 28m

A very human look at a very alien environment, Adapt is the first of the four-part series. Floating through a mass of wires, tunnels, tubes and laptops are the four featured astronauts on the 22-year-old 'outpost of humanity'.

'The power of adaptation is one of the most beautiful aspects of the human mind,' declares David Saint-Jacques, as the crew get accustomed to 'micro-gravity' and the disorientation of '16 sunrises and 16 sunsets a day.'

As awe-inspiring images of the Earth pass underneath, the team tuck in to an *amuse-bouche* of brie and chutney and it's the ordinary that calls your attention. The most important place on the \$160 billion station? The bathroom.



The Overview Effect | 6m

The Overview Effect is a cognitive shift in awareness reported by some astronauts during spaceflight. This film tries to recreate the effect to stimulate an 'instant global consciousness' and a desire to protect the planet.



more space stuff!



1st Step | 11m

There's just so much to take in. Orbiting and standing on the moon with photo-realistic lunar panoramas based on Nasa data. Crammed inside the tiny capsule with Aldrin, Armstrong and Collins. But it's the phenomenal view of Apollo 11 exiting Earth's orbit from an impossible standpoint that takes the breath away.

A superb narration conveys the enormity of mankind's greatest achievement. With judicious use of genuine crackling audio recordings of the time and clever use of archive footage, 1st step succeeds in transporting you back over a half a century. It's impossible not to be moved.

An incredible piece of filmmaking from Faber Courtial. One of the greatest docs ever made about the moon landings.



2nd Step | 14m

An imaginary journey into the near future, 2nd step takes you to the Shackleton-Crater on the dark side of the moon, flying over the lunar base that will be the jump-off point for the mission to Mars.

One lunar night is equivalent to 14 back on Earth, seen as a fragile blue crescent hanging in the blackness of space.

Orbiting the red planet, you are soon standing with the golden-helmeted astronauts on the surface of the Martian desert, gazing open-mouthed at the edge of the deepest canyon in the solar system.

And in a fantastical finale, the search for a second Earth takes us to an unknown exoplanet, in what would be 'the greatest discovery that man could make'. Epic.

The Spacewalker | 4m

There's a blizzard swirling around the launchpad of the Voskhod 2 rocket as it prepares for blast off in March, 1965. Step into the shoes of Soviet cosmonaut Alexei Leonov as he becomes the first human in history to float freely in space.



even more space stuff!



Space Explorers: A New Dawn | 19m

Perhaps it's the Russian-language course that young US astronaut Jeanette J. Epps is taking that best illustrates the post-Space Race world she grew up in.

Unity and co-operation seem a pretty good course of action seeing as the survival of the human race depends on it, as 'either we will have destroyed the Earth or the Sun will have blown up'.

The interview-led narration follows the training of a new class of deep space explorers from being lowered into a swimming pool - sorry, 'Buoyancy Lab' - to flying in the cockpit of a T-38 jet. There's even a moment that you realise that you are watching someone train using VR - in VR. From Felix & Paul.



Space Explorers: Taking Flight | 20m

Beginning on the launch pad of SpaceX, you could be forgiven for thinking this will be a dive into the egos of tech billionaires Bezos, Branson and Musk.

Instead we are soon surrounded by bleating Mongolian camels in the Kazakhstan desert, site of the world's largest space launch facility, to witness various awe-inspiring rockets thunder into the sky.

This episode is mostly narrated by kindly Russian cosmonauts, undergoing training for missions to the International Space Station. The overwhelming message is of civility. Thankfully directors Felix & Paul placed the cameras by the side of, and not on, the centrifuge simulation.

Home Planet | 8m

An eight minute orbit of the Earth, all one shot, taken from the Cupola of the International Space Station. It's a simple as it is profound. Play spot the country as our world rotates on its axis. Mesmerising and sobering at the same time.



underwater films!



Immerse | 9m

Poetic, educational and affecting, Immerse is simply the best 360 underwater film out there.

Look right down the mouth of a manta ray, go eye to eye with green sea turtles and dive with shoals of red snappers and grey sharks among the coral reefs of Palau. The film is mixed with exquisite animations of coral polyps and mass coral spawning on the full moon.

It's made by Hydrous, a non-profit which raises ocean awareness and scientific understanding, led by marine biologist Dr Erika Woolsey.

As she says: 'When you see the beauty and the magic of the ocean this closely how could you not want to protect it?'



Polar Obsession | 7m

National Geographic photographer Paul Nicklen traverses 550 miles of the roughest seas in the world to reach Antarctica. 'It's like you are entering this dreamland and the dream is real,' he says.

Floating like a speck amongst the spectacular icebergs, he has a close encounter with a humpback whale before meeting the star of the underwater show - a 12 foot long leopard seal, 'bigger than a grizzly bear'.

After some dramatic threat displays, the seal decides to show just how good he is at catching a penguin.

It's an astonishing and unique hunting sequence captured at the very edge of the South Pole.

AirPano Jellyfish Bay | 3m

From the Russian hi-res film specialists AirPano comes a short but breathtaking dive into a smack of thousands of jellyfish in Raja Ampat, Indonesia. Recorded in 8K by Alexey Tishchenko with a simple musical score.



more underwater films!



Dive Blue Planet VR | 9m

Diver Tiare Boyes narrates in real time as you plunge into the green seas of Canada in search of the world's largest octopus.

In between gulps of air, Boyes directs your gaze with her torch and her patter as she swims through the emerald underwater kelp forest. After pausing to show off an enormous wolf eel, it's time for the star, the Giant Pacific Octopus.

Camouflaged, and at almost 10 metres long, it emerges right in front of your eyes. It's a nocturnal carnivorous predator and as smart as a house cat.

This is classic BBC Natural History Unit writ large in VR. It's a guided safari that even has time for a sea lion cameo, as a young male comes in to have a look.



Dolphin Man: Dive | 6m

'I have a relationship with the depths - cold, dark, vacant, pressure,' says William Trubridge, a quietly-spoken free diver.

Just a lithe body in a wetsuit with no oxygen, he descends vertically into the bluest of Blue Holes, where he's achieved many of his 14 world records.

Trubridge has gone eight minutes without breathing and broken through the 100 metre barrier without fins.

Directed by Benoît Lichté, Dive is one of a trio of films with Dolphin Man. Darker and darker, we head into the depths.

'Gases play tricks on your mind,' he says, as he reflects on the dangers and his own calmness in the face of them. And, breathe.

700 sharks | 7m

A heart-in-the-mouth glimpse at the largest gray reef shark pack in the world in French Polynesia. It's daytime, when the 'wall' of sleek torpedoes remains static, hours before a feeding frenzy to gorge on groupers you can only imagine.

REFERENCE!

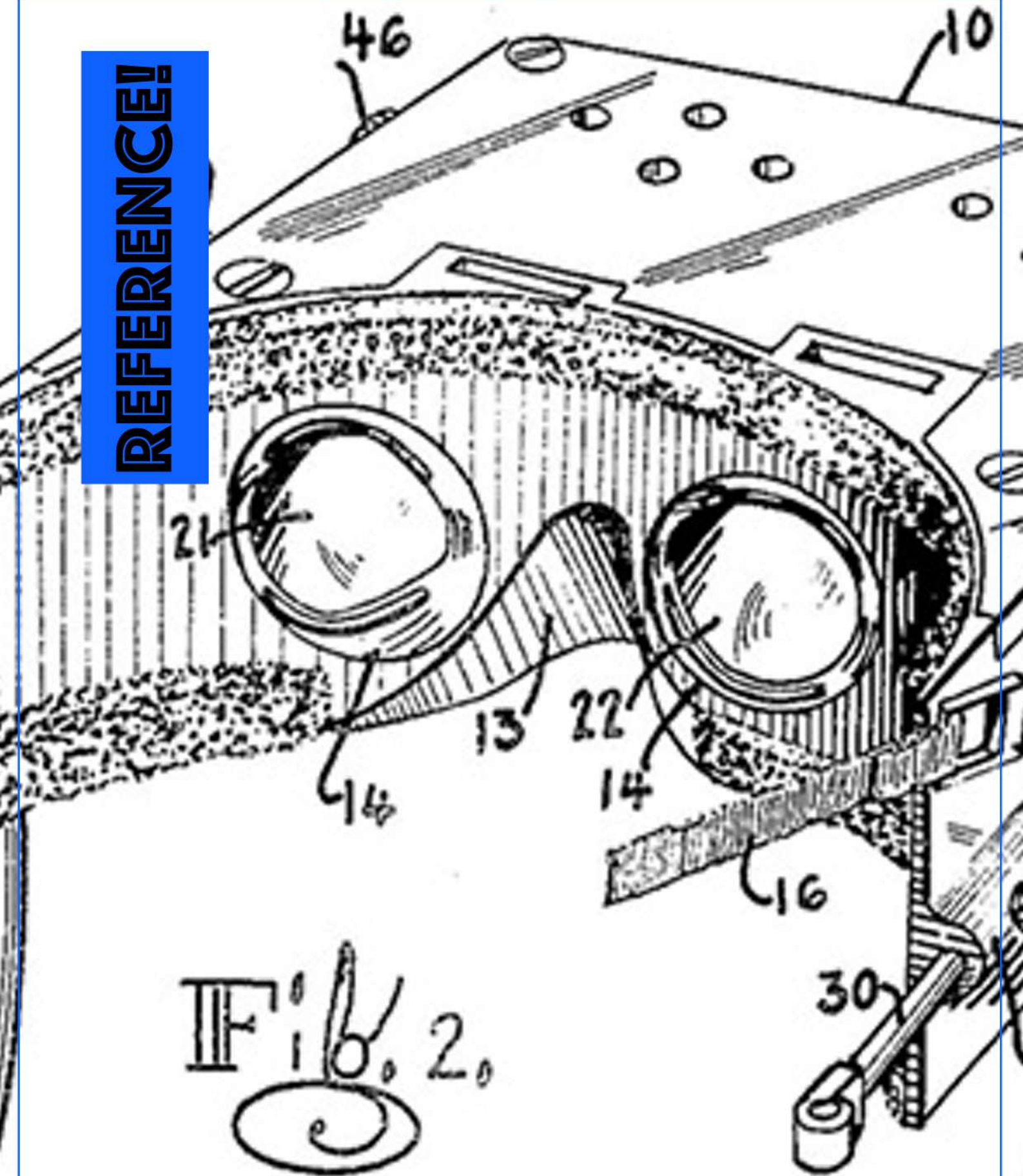

Fig. 2.

BABY STEPS!

ABSOLUTE BEGINNERS: GETTING STARTED OUT OF THE BOX!

I just got it out of the box, now what do I do?! Turn it on by doing a short press of the button on the right side of the headset. You can turn it off by doing a long press! It'll go into standby on its own.

Download the Meta Quest app to your phone! You have to pair it with your headset via bluetooth.

Set up your Meta account! The requirement to link to a valid Facebook account was removed in August 2022. Enter your bank details and off you go!

WTF does that mean?! It's an alphabet soup of three-letter acronyms out there! Check out the glossary!

Set up your Guardian boundary! Clear some space in your room and follow the tutorial in the headset. Be careful and aware - don't faceplant the fireplace or tread on your cat!

The Oculus button is your best friend! See that one marked with ? It's the one that is depressed under the joystick on the right controller. A long press will always re-centre your view and a short press will exit any app back to the menu.

Charging! The green light means it's fully charged (you get about two hours), orange is charging, white in use and red when there's only 10% left. You can leave it charging without damaging the battery.

HAND TRACKING: HOW TO ENABLE, GESTURES AND ADVICE!

Turn it on! Point and pinch to select and scroll. Watch the 'Hands' video tutorial pre-installed in your apps to learn how to do the basic gestures. Make sure you have plenty of light and contrast!
[settings](#) > [virtual workspace](#) > [hands](#)

Hold your hand palm up and make a pinching motion to call up a shortcut menu to reset view, take screenshots and more. Hand tracking 2.0 was launched together with firmware v39 bringing many improvements including hand-over-hand.

CUSTOM HOMES: MAKE YOUR QUEST 2 HOME YOUR OWN!

Your **virtual environment** is the default area when you start the headset or exit an app. You can choose passthrough as default (toggle the eye symbol in settings), or from one of a dozen spaces like Winter Lodge or Ryokan Retreat.
[settings](#) > [virtual workspace](#) > [virtual environments](#)

You can invite other users into your space and jump into games together or watch 360 films. Once the menus are closed you can teleport around your home. There are loads more Custom Homes on Sidequest. View and install them directly from the in-VR app.

HINTS, GUIDELINES, TIPS AND TRICKS

BASICS: LENSES, GUARDIAN, PASSTHROUGH & IPD!

Look after the lenses! Never leave them exposed to sunlight, even for a few seconds! Never clean the lens with anything but a lens cloth (your t-shirt can scratch them). I keep mine turned away from the window and always have a cloth on hand. Or use a lens protector when not in use. A few arena-scale games require large spaces. It's safe to use the Quest 2 outside as long as you don't allow sunlight direct on the lenses. For tracking reasons it's best to play at dawn or dusk or in a floodlit area.

Set your IPD! IPD is the distance between your pupils (interpupillary distance). Once you get this dead on, it makes a world of difference - no more blurry edges! It's fixed at 58/63/68mm options on Quest 2, but you can manually force in-between settings. You can use a ruler and a mirror or the quest IPD app on Sidequest.

Passthrough! Enable this in settings so you can double-tap on the side of your headset at any time. You can now blend your home environment via a slider with passthrough - it's located next to volume and brightness.
[guardian > general > double tap for passthrough](#)

Motion sickness! If you are new to VR avoid games marked with 🌀 this symbol in the guide until you get your VR 'legs'! Play in short sessions. If you feel sick stop playing immediately and don't try to 'power through'.

Setting the guardian boundary! It's a necessary evil but you can make it better. Lower roomscale boundary sensitivity in guardian settings to avoid more immersion killers. You can adjust four levels which trigger virtual walls depending on distance or movement.
[guardian > roomscale > boundary sensitivity > advanced](#)

With the stationary boundary the virtual walls are replaced with passthrough. You can even switch the guardian off entirely in developer mode (you must create an account first) at your own risk!
[system > developer > guardian](#)

With room mapping you can mark out your walls, doors and windows. Add a sofa, desk or other rectangular object.
[experimental > room setup](#)

Add a keyboard (Magic Keyboard)
[virtual workspace > keyboard](#)

Switch Space Sense on to detect the movement of people or animals
[guardian > roomscale > space sense](#)

Stick drift? After prolonged use your controller may suffer from drift. Try blowing in compressed air (a camera dust air pump will do) or use an electrical contact cleaner (not lubricant!). You can also make adjustments in settings
[hands and controllers > controllers > thumbstick range and deadzone](#)



HINTS, GUIDELINES, TIPS AND TRICKS

SHARING: RECORDING, CASTING & MIXED REALITY!

Recording video! To record in 16:9 aspect ratio first turn on the advanced camera settings

[experimental](#) > [advanced camera settings](#)

Then you can tweak your settings to record with a frame rate up to 36 fps and bitrate up to 20 mbps with optional image stabilisation. You can also turn off the red dot recording light

[system](#) > [camera](#)

Mixed reality! You can record mixed reality in 3rd person view in a built-in feature on the mobile app (requires iPhone XS).

Monthly firmware updates! Automatic and roll out at different times across different regions. Release notes [here](#).

Casting! Be aware it eats the battery fast! Many TVs aren't compatible. One fail-safe method is to cast to a phone and then connect it to the TV via HDMI.

Multi-user! You can add up to three other accounts in addition to yours on a single headset. Switch between them by clicking on your profile image. It's useful to keep game progress save settings apart.

[accounts](#) > [add account](#)

App sharing! Log into two Quests with the same primary account, then turn on app sharing and add a secondary account on one of them. Bingo!

[accounts](#) > [app sharing](#)

Screenshots! Shortcut: Hold **O** and press trigger on either controller!

ACCESSIBILITY: VR FOR ALL

Hearing loss Adjust left-right audio balance and switch between mono or stereo [accessibility](#) > [hearing](#)

Colourblind Apply a display filter to help distinguish colours [accessibility](#) > [vision](#) > [colour correction](#)

Wheelchair users Increase your height as if standing. Works across most apps. [accessibility](#) > [mobility](#) > [adjust height](#)

Missing fingers Some apps that use hand tracking - like Hand Physics Lab and Waltz of the Wizard - allow you to remap your digits.

Vision loss Change the text size for the universal menu and supported apps. [accessibility](#) > [vision](#) > [text size](#)

Controller vibration intensity Reduce haptic feedback [accessibility](#) > [mobility](#) > [controller vibration](#)

THE BIG PICTURE

These are exciting times for VR. Released in October 2020, this graph shows the spectacular rise of the Quest 2.

sales in millions
(figures not released)

VISUALISING THE QUEST 2 EFFECT

'Quest 2 has outsold all previous Oculus headsets combined'

Facebook Reality Labs VP Andrew Bosworth | March 30 2021

Source: Bloomberg

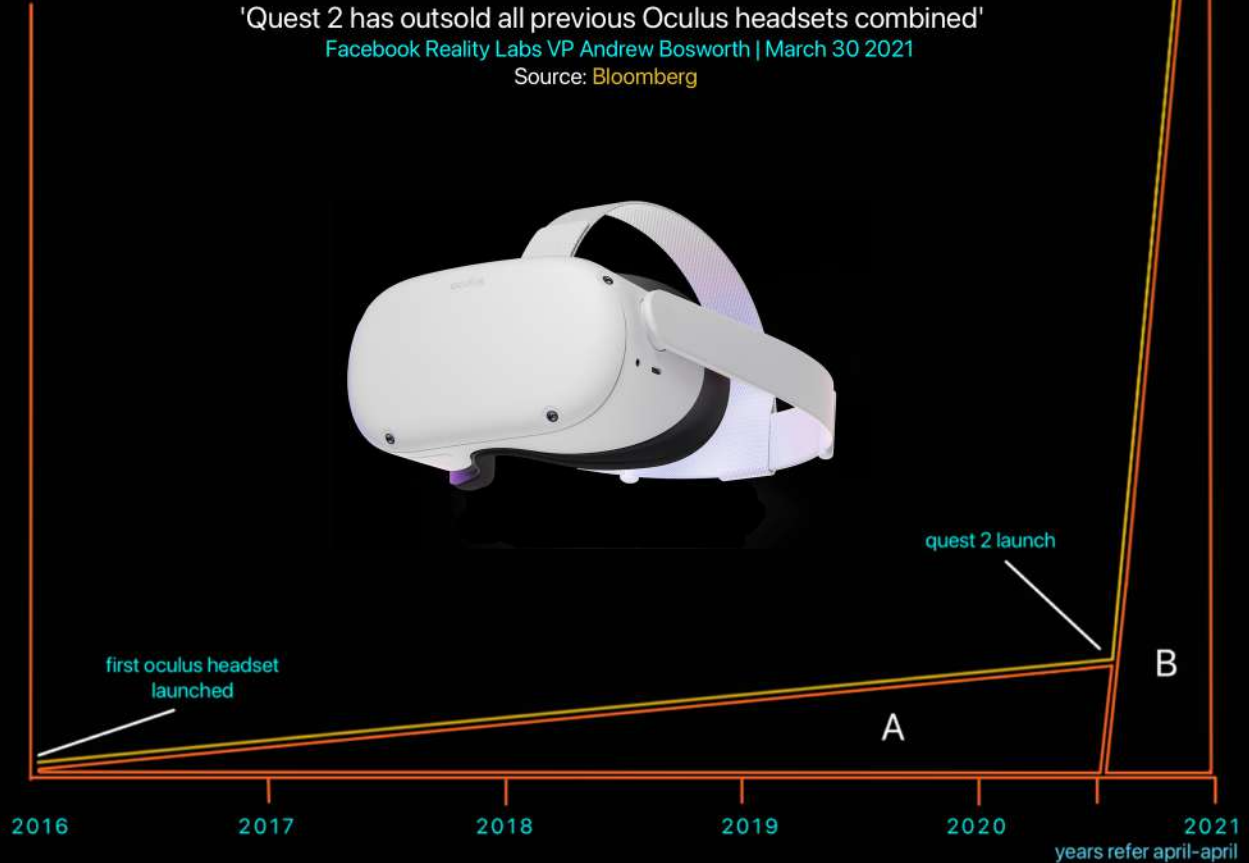

17.2 MILLION*

*Estimated Quest 2 sales.
Official figures not released

Source: IDC Sept 2022

1000%

Game sales are up as much as
ten-fold since Quest 2 launch

Source: Cloudhead Labs

\$1.5 BILLION

User spend on content on
the Quest store and App Lab

Source: Meta

\$180 MILLION

Estimated revenue generated
by a single title - Beat Saber

Source: RoadtoVR

\$10 MILLION+

Revenue earned by 33 Quest 2
titles. 120 have earned \$1M+

Source: Meta

1000+

Number of apps on App Lab.
There are 350+ on the store.

Source: r/applab

a brief history of vr!

A brief history of VR from 1832 to the launch of the Quest 2 in 2020. Headset (HMD) development is in **green**, cameras in **yellow** and general in **blue**.

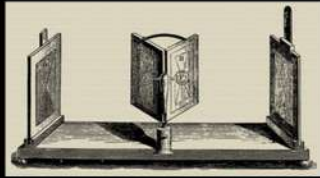

1832

stereopsis
stereoscope



1935

pygmalion's spectacles
sci-fi story



1956

sensorama
vr booth



1968

sword of damocles
first hmd



1989



1985



1979
vital helmet
military hmd



1991
virtuality
vr arcade



1995

virtual boy
gaming hmd



2010

oculus rift prototype



facebook buys oculus
2014

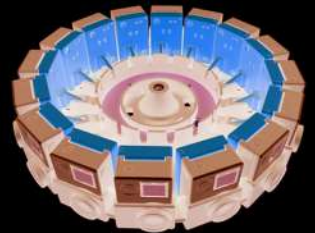

multi-camera rigs
gopro jump
2015



quest pro

2022

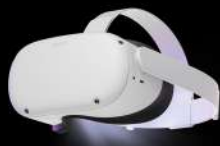

quest 2

2020



quest

2019

insta360 pro 2
8K pro cameras



standalone hmds
go

2018

insta360 one x
5.7K cameras

tethered hmds
oculus rift htc vive psvr

2016

gear 360
4K cameras

gear vr cardboard
phone hmds

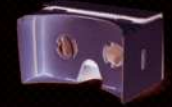

WTF DOES THAT MEAN?!

GLOSSARY: KNOW YOUR DIORAMAS FROM YOUR PANCAKES!

vr terms | **3dof** (three degrees of freedom) restricted to following head movement **6dof** (six degrees of freedom) allows free movement **UI** user interface **FFR** (fixed foveated rendering) a way to economise processing power by keeping hi-res in the centre of your vision and lo-res at the periphery without impacting on your ... **UX** user experience! **agency** the ability to act in and influence a vr environment **refresh rate** the higher the refresh rate, the smoother the visual experience. Quest 2 can run at 120Hz **latency** the delay between your action and the headset's reaction **inside-out tracking** in-built cameras mapping your 3D space **PCVR** VR tethered to a gaming PC through the oculus link cable or wireless using the **air link** feature **HMD** head mounted display i.e. a headset **FOV** field of view - the Quest 2 is 92° horizontal (compared to our 200° -220° in real life) **XR** cross-reality - industry term for anything VR and ... **AR** augmented reality **LBE** location-based entertainment eg VR arcade **sideload** just copying files to the headset **IP** an original game (from Intellectual Property) **devs** the developers - our heroes! **metaverse** shorthand for either 'I don't know what I'm talking about' and/or 'I want to make a load of cash out of you'

gamer terms | **FPS** first-person shooter **wave shooter** vr space invaders genre **rail shooter** from a fixed position **jump scare** cheap horror trope **NPC** non-playing character **spawn** the live creation of a game object **god-mode** turns the game into a ... **diorama** interactive miniature **DLC** downloadable content (game add-ons) **sandbox** open-world exploration **melee** close combat **bullet hell** raining projectiles **non-euclidean** impossible spaces **virtual beings** AI artificial people **edgelords** rebel fakers **squeakers** toxic kids **roguelite** procedural labyrinths with **permadeath** ... you die, start again **lore** backstory **pancake** pejorative term for flat non-VR games **gunstock** 3D-printed controller pimping **hotas** controller pimping (from hands on throttle-and-stick) **PvP** player vs player **dojo** training area **asymmetric** VR player against non-VR player **cel-shading** cartoon graphic style **loadout** the weapons you choose to take into battle **mech** fighting machine you drive **f2p** free to play **QoL** fixes to playability (Quality of Life) **SBM** skill-based matchmaking (for multiplayer fairness) **nerf** weapon downgrade **buff** weapon upgrade **grinding** do repetitive tasks to gain ... **XP** experience points!

PRIVACY: BIOMETRICS, ANTI-TRUST LAWS AND YOUR DATA

As from August 2022 you no longer need a **facebook account**. The requirement has been replaced by a Meta account which, in turn, replaces the previous Oculus account.

Remember that with inside-out tracking, **the information from the cameras seeing your room is sent to meta**: 'When you set up the Oculus Guardian System we receive information about the play area that you have defined.' That information is unspecified.

Meta also **collects biometric data on your physical features** like your height and hand size; your voice (if not disabled) and your location. For more information, see the Oculus legal documents [here](#).

According to a paper in the respected scientific journal Nature, a simple machine learning model can **identify participants from less than five minutes of tracking data** at above 95% accuracy. See [here](#).

You can **feedback** to Meta about these or any other issues [here](#).

recording vr!

Want to make your own films? A decent kit now costs under US\$1,000 ...



insta360 one x 2
camera | US\$430
5.7K 30fps



zoom h3-vr
audio | US\$250
spacial audio



manfrotto tripod
accessory | US\$180
reliability



extended selfie stick
accessory | US\$40
10ft telescopic stick
for drone effect

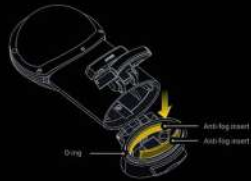

dive case
accessory | US\$80
underwater to 45 meters

Or go pro ...



insta360 pro 2
camera | US\$4,599
8K 30fps

editing vr!

You can do it on a phone, I use a mac



mac book pro
laptop | varies
OSX 10.15+



insta360 studio 2021
app | free
stitching | v3.6.6



final cut pro X
app | varies
editing | v10.5.2



AUBIKA HEAD STRAP WITH BATTERY \$46



VR COVER FACIAL INTERFACE \$35

SYNCH IT DEEP IN-EAR PHONES \$20



AMVR CONTROLLER GRIP STRAP Q2HP1 \$17

PIMP YOUR QUEST 2!

MICROFIBRE CLOTH



LENS PROTECTOR



3D PRINTED PADDLE



SWEATBAND



WARNING! DON'T BUY THE OCULUS ELITE STRAP! IT BREAKS.

GIBBY'S GUIDE TO THE QUEST 2!

100,000+ DOWNLOADS | A FREE INSPIRATION IN THE | 200+ DISCOVERIES | PODCAST! LATEST NEWS

FOR A MONTH (2017) | INSPIRATION | ART THERAPY | VISUAL CHALLENGES | LIVE PICTURES | TABLES | FORTNITE

the mental health issue!

MEET THE DEVIL WHO BEARS MANY FACETS: COLLEEN

BEHIND THE SCENES | FILM & ANIMATION REVIEWS | TOP 100 GAMES RANKED AND REVIEWED!

GIBBY'S GUIDE TO THE QUEST 2!

100,000 DOWNLOADS | A FREE INSPIRATION IN THE | 200+ DISCOVERIES | PODCAST! LATEST NEWS

FOR A MONTH (2017) | ART THERAPY | VISUAL CHALLENGES | LIVE PICTURES | TABLES | FORTNITE

THE PASSTHROUGH PIONEERS!

MEET THE DEVIL

BLASTOFF! SKYGAZE! 2076! Verminion! YouTube VR! VIRTU! 3! Hologram! PHOTOGRAPHY! UPDATE!

BEHIND THE SCENES | FILM & ANIMATION REVIEWS | TOP 100 GAMES RANKED AND REVIEWED!

GIBBY'S GUIDE TO THE QUEST 2!

100,000 DOWNLOADS | A FREE INSPIRATION IN THE | 200+ DISCOVERIES | PODCAST! LATEST NEWS

FOR A MONTH (2017) | ART THERAPY | VISUAL CHALLENGES | LIVE PICTURES | TABLES | FORTNITE

QUILLUSTRATORS!

MEET THE DEVIL WHO BEARS MANY FACETS: COLLEEN

FOR A MONTH (2017) | ART THERAPY | VISUAL CHALLENGES | LIVE PICTURES | TABLES | FORTNITE

BEHIND THE SCENES | FILM & ANIMATION REVIEWS | TOP 100 GAMES RANKED AND REVIEWED!

GIBBY'S GUIDE TO THE QUEST 2!

50,000 DOWNLOADS | A FREE INSPIRATION IN THE | 200+ DISCOVERIES | PODCAST! LATEST NEWS

FOR A MONTH (2017) | ART THERAPY | VISUAL CHALLENGES | LIVE PICTURES | TABLES | FORTNITE

THE FUTURE AND BEYOND

MEET THE DEVIL WHO BEARS MANY FACETS: COLLEEN

BEHIND THE SCENES | FILM & ANIMATION REVIEWS | TOP 100 GAMES RANKED AND REVIEWED!

GIBBY'S GUIDE TO THE FREE STUFF!

40,000 DOWNLOADS | A FREE INSPIRATION IN THE | 200+ DISCOVERIES | PODCAST! LATEST NEWS

FOR A MONTH (2017) | ART THERAPY | VISUAL CHALLENGES | LIVE PICTURES | TABLES | FORTNITE

132 FREE EXPERIENCES!

46 FREE FULL GAMES & APPS | 38 FREE GAME TRIALS | 48 FREE FILMS & ANIMATIONS!

BEHIND THE SCENES | FILM & ANIMATION REVIEWS | TOP 100 GAMES RANKED AND REVIEWED!

GIBBY'S GUIDE TO VIRTUAL REALITY!

35,000 DOWNLOADS | A FREE INSPIRATION IN THE | 200+ DISCOVERIES | PODCAST! LATEST NEWS

FOR A MONTH (2017) | ART THERAPY | VISUAL CHALLENGES | LIVE PICTURES | TABLES | FORTNITE

IMPOSSIBLE SPACES!

100+ ORIGINAL REVIEWS OF GAMES, FILMS AND ANIMATIONS! UNRATED AND UNDEPENDENT - 1 PIV FOR ALL APPS!

NATURAL WALKING IN VR! TRAVELING TEA FOR GOOD! LAUNCHING!

BEHIND THE SCENES | FILM & ANIMATION REVIEWS | TOP 100 GAMES RANKED AND REVIEWED!

GIBBY'S GUIDE TO VIRTUAL REALITY!

30,000 DOWNLOADS | A FREE INSPIRATION IN THE | 200+ DISCOVERIES | PODCAST! LATEST NEWS

FOR A MONTH (2017) | ART THERAPY | VISUAL CHALLENGES | LIVE PICTURES | TABLES | FORTNITE

CRASHLAND!

THE YOUNGEST GAME IN VR! MEET THE DEVIL LILIA AP CALABO!

BEHIND THE SCENES | FILM & ANIMATION REVIEWS | TOP 100 GAMES RANKED AND REVIEWED!

GIBBY'S GUIDE TO VIRTUAL REALITY!

108 FREE EXPERIENCES!

31 FREE FULL GAMES & APPS | 29 FREE GAME TRIALS | 48 FREE FILMS & ANIMATIONS!

BEHIND THE SCENES | FILM & ANIMATION REVIEWS | TOP 100 GAMES RANKED AND REVIEWED!

GIBBY'S GUIDE TO VIRTUAL REALITY!

MORE THAN 100 EXPERIENCES TRAIL AND TESTED!

the future and beyond

FOR A MONTH (2017) | ART THERAPY | VISUAL CHALLENGES | LIVE PICTURES | TABLES | FORTNITE

BEST OF THE QUEST!

96 RECOMMENDED GAMES & APPS | 72 FILMS & ANIMATIONS | 84 ORIGINAL REVIEWS!

BEHIND THE SCENES | GLOSSARY | HISTORY OF VR | NEW TRAILERS! APP LAB! V3D!

GIBBY'S GUIDE TO VIRTUAL REALITY!

MORE THAN 100 EXPERIENCES TRAIL AND TESTED!

the future and beyond

FOR A MONTH (2017) | ART THERAPY | VISUAL CHALLENGES | LIVE PICTURES | TABLES | FORTNITE

APP LAB SPECIAL! \$750!

BEHIND THE SCENES | GLOSSARY | HISTORY OF VR | NEW TRAILERS! APP LAB! V3D!

GIBBY'S GUIDE TO VIRTUAL REALITY!

MORE THAN 100 EXPERIENCES TRAIL AND TESTED!

the future and beyond

FOR A MONTH (2017) | ART THERAPY | VISUAL CHALLENGES | LIVE PICTURES | TABLES | FORTNITE

40 25 OLYMPICS!

BEHIND THE SCENES | GLOSSARY | HISTORY OF VR | NEW TRAILERS! APP LAB! V3D!

GIBBY'S GUIDE TO VIRTUAL REALITY!

MORE THAN 100 EXPERIENCES TRAIL AND TESTED!

the future and beyond

FOR A MONTH (2017) | ART THERAPY | VISUAL CHALLENGES | LIVE PICTURES | TABLES | FORTNITE

WIN \$100!

BEHIND THE SCENES | GLOSSARY | HISTORY OF VR | NEW TRAILERS! APP LAB! V3D!

GIBBY'S GUIDE TO VIRTUAL REALITY!

MORE THAN 100 EXPERIENCES TRAIL AND TESTED!

the future and beyond

FOR A MONTH (2017) | ART THERAPY | VISUAL CHALLENGES | LIVE PICTURES | TABLES | FORTNITE

MEET THE DEVIL WHO BEARS MANY FACETS: COLLEEN

BEHIND THE SCENES | GLOSSARY | HISTORY OF VR | NEW TRAILERS! APP LAB! V3D!

GIBBY'S GUIDE TO VIRTUAL REALITY!

MORE THAN 100 EXPERIENCES TRAIL AND TESTED!

the future and beyond

FOR A MONTH (2017) | ART THERAPY | VISUAL CHALLENGES | LIVE PICTURES | TABLES | FORTNITE

MEET THE DEVIL WHO BEARS MANY FACETS: COLLEEN

BEHIND THE SCENES | GLOSSARY | HISTORY OF VR | NEW TRAILERS! APP LAB! V3D!

GIBBY'S GUIDE TO VIRTUAL REALITY!

MORE THAN 100 EXPERIENCES TRAIL AND TESTED!

the future and beyond

FOR A MONTH (2017) | ART THERAPY | VISUAL CHALLENGES | LIVE PICTURES | TABLES | FORTNITE

MEET THE DEVIL WHO BEARS MANY FACETS: COLLEEN

BEHIND THE SCENES | GLOSSARY | HISTORY OF VR | NEW TRAILERS! APP LAB! V3D!

GIBBY'S GUIDE TO VIRTUAL REALITY!

MORE THAN 100 EXPERIENCES TRAIL AND TESTED!

the future and beyond

FOR A MONTH (2017) | ART THERAPY | VISUAL CHALLENGES | LIVE PICTURES | TABLES | FORTNITE

MEET THE DEVIL WHO BEARS MANY FACETS: COLLEEN

BEHIND THE SCENES | GLOSSARY | HISTORY OF VR | NEW TRAILERS! APP LAB! V3D!

LATEST EDITION!

**SEPT/OCT 2022
THE FUTURE
OF MEDICINE**

25% OFF GAMES!

**CLICK HERE FOR
REFERRAL LINKS
AND SUPPORT
THE GUIDE!**

GIBBY'S GUIDE TO THE QUEST 2!

A FREE INDEPENDENT VR ZINE!

VR19 | SEPT/OCT 2022 **LOVINGLY CURATED!** COMPLETE BEGINNER'S GUIDE! FULLY REVISED & UPDATED!

TOP 100 RANKED & REVIEWED

299 FEATURED TITLES

140 PAGES

300,000 DOWNLOADS!

PLUS! QUEST PRO LAUNCH!

the future of medicine

MEET THE DEVELOPERS! TOMÁŠ BRŇGÁL VIRTUAL MEDICINE | TOMEK KUPIDURA MEDICAL HOLODECK

EVEN MORE DLC!

**PODCASTS &
DEVELOPER
INTERVIEWS!**

podcasts!

GIBBY'S GUIDE TO THE QUEST 2!

meet the devs!

GIBBY'S GUIDE TO THE QUEST 2!

TALES FROM AROUND THE WORLD | SWITZERLAND | SWEDEN | ITALY | ROMANIA | POLAND | BRAZIL | HUNGARY | JAPAN | CHINA | HOLLAND | AUSTRIA | ISRAEL | CANADA | SPAIN | MALTA | USA

praise for the guide!



Comments from Redditors and developers. Thank you!

'YOUR LABOUR OF LOVE IS MIND-BLOWING'

'I've never seen a more complete document about VR before!'

'REAL PASSION & STYLISH EXECUTION'

'It's absolutely amazing. I love to see clear up-to-date guides that work for everyone!'

'SUCH HIGH QUALITY. SO. MUCH. CONTENT.'

'So comprehensive and saves me hours of looking all this shit up myself!'

'AMAZING' 'FANTASTIC' 'INSANELY GOOD'

'I haven't seen a finer set of games magazines since The Escapist!'

'A PHENOMENAL AMOUNT OF CURATION'

'I have this 80s feeling of games magazines and it feels good!'

'COLOURFUL, INFORMATIVE & FUN'

'This will help many people to dive into VR!'

'MY MOST TRUSTED SOURCE'

this is a **BS**-free zone!

**300,000
DOWNLOADS!**



MADE IN ENGLAND